

K L I M A U R E Đ A J I

CJENIK KUĆNE SERIJE



2026.



KLIMA UREĐAJI

Činiš se

kao netko tko čuva naš planet.

Jedini je kojeg imamo.

Činiš se kao netko tko je izabrao **Mitsubishi Electric**.



Mitsubishi Electric, uživanje u idealnoj klimi.





MSZ-RW

- 3D I-See senzor
- Plasma Quad Plus filter
- Econo Cool funkcija
- Tjedni tajmer
- Samodijagnoza
- Automatsko prebacivanje načina rada
- Samodijagnoza
- Dvostruki premaz
- I-Save način rada
- Automatska dvostruka krilca
- Noćni način rada

A+++

 -30 ~ 24°C
-10 ~ 46°C

**Mitsubishi Electric izumio je ultra-
učinkovito rješenje za "posebno grijanje".**

Njegove glavne prednosti? Jamstvo kvalitetnog grijanja čak i u ekstremnim uvjetima **do -30°C** i održavanjem snage grijanja od +7°C do -25°C. Uz Hyper Heating Ultimate tehnologiju otkrit ćete neusporedivu učinkovitost grijanja.

MODEL	UČINAK (W)		SEER / SCOP ENER. KLASA	DIMENZIJE V / Š / D (mm)	CIJENA (€)	
	HLADENJE	GRIJANJE			VPC	MPC
MSZ-RW25VG	2500	3200	11,2 / 5,2	305 / 998 / 247	635,00	
MUZ-RW25VGHZ	(900-3500)	(800-6300)	(A+++ / A+++)	714 / 800 / 285	1286,90	1.921,90 2.402,38
MSZ-RW35VG	3500	4000	9,4 / 5,1	305 / 998 / 247	752,94	
MUZ-RW35VGHZ	(1000-4000)	(1100-7000)	(A+++ / A+++)	714 / 800 / 285	1546,14	2.299,08 2.873,85
MSZ-RW50VG	5000	6000	7,6 / 4,6	305 / 998 / 247	779,27	
MUZ-RW50VGHZ	(1400-5800)	(1800-8700)	(A++ / A++)	880 / 840 / 330	2305,23	3.084,50 3.855,63

Uključeno: bežični upravljač

CJEVOVOD	UČINAK (kW)		
	2,5	3,5	5,0
Max. visinska razlika [m]	12	12	15
Max. duljina instalacije [m]	20	20	30
Promjer cijevi tekuće faze [mm]	6,35	6,35	6,35
Promjer cijevi plinovite faze [mm]	9,52	9,52	9,52

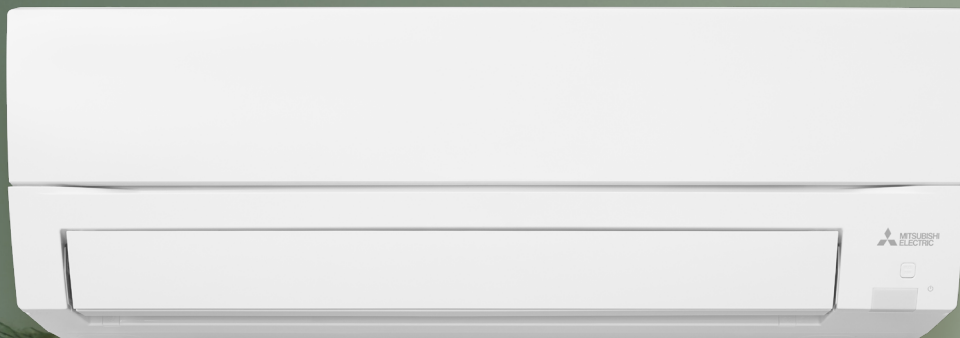

MSZ-FT

- V-blocking filter
- Econo cool funkcija
- Tjedni tajmer
- Automatsko prebacivanje načina rada
- I-Save način rada
- Noćni način rada

A+++
R32

-25 ~ 24°C
-10 ~ 46°C

MODEL	UČINAK (W)		SEER / SCOP ENER. KLASA	DIMENZIJE V / Š / D (mm)	CIJENA (€)	
	HLADENJE	GRIJANJE			VPC	MPC
Napajanje: 1 Ph / 230 V / 50 Hz						
MSZ-FT25VGK-E2	2500	3200	8.6 / 4.6	280 / 838 / 229	500,65	1.517,34 1.896,68
MUZ-FT25VGHZ-E2	(800-3500)	(900-6200)	A+++ / A++	550 / 800 / 285	1016,69	
MSZ-FT35VGK-E2	3500	4000	8.6 / 4.6	280 / 838 / 229	581,01	1.801,67 2.252,09
MUZ-FT35VGHZ-E2	(800-4000)	(900-6600)	A+++ / A++	714 / 800 / 285	1220,66	
MSZ-FT50VGK-E2	5000	5000	7.2 / 4.3	280 / 838 / 229	618,03	2.652,83 3.316,04
MUZ-FT50VGHZ-E2	(800-5200)	(900-7800)	A++ / A+	714 / 800 / 285	2034,8	

Ukjučeno: bežični upravljač

CJEVOVOD	UČINAK (kW)		
	2,5	3,5	5,0
Max. visinska razlika [m]	12	15	15
Max. duljina instalacije [m]	20	30	30
Promjer cijevi tekuće faze [mm]	6,35	6,35	6,35
Promjer cijevi plinovite faze [mm]	9,52	9,52	9,52



MSY-TP

- Samodijagnoza
- Automatska dvostruka krilca
- Tjedni tajmer

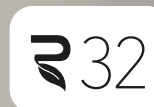

A+++

 -25 ~ 46°C

MODEL	UČINAK (W)		SEER / SCOP ENER. KLASA	DIMENZIJE V / Š / D (mm)	CIJENA (€)	
	HLADENJE	GRIJANJE			VPC	MPC
Napajanje: 1 Ph / 230 V / 50 Hz						
MSY-TP35VF-E2	3500	/	9.0	305 / 923 / 250	630,04	
MUY-TP35VF-E2	(1500-4000)	/	A+++	550 / 800 / 285	951,07	1.581,11 1.976,39
MSY-TP50VF-E2	5000	/	8.0	305 / 923 / 250	781,82	
MUY-TP50VF-E2	(1500-5700)	/	A++	550 / 800 / 285	1806,04	2.587,86 3.234,83

Nije uključen bežični upravljač. Potrebno je dodatno naručiti žičani daljinski upravljač PAR-41MAAB i jedan interface MAC-334IF-E

CJEVOVOD	UČINAK (kW)	
	3,5	5,0
Max. visinska razlika [m]	12	12
Max. duljina instalacije [m]	20	20
Promjer cijevi tekuće faze [mm]	6,35	6,35
Promjer cijevi plinovite faze [mm]	9,52	9,52

MSZ-LN

KIRIGAMINE STYLE

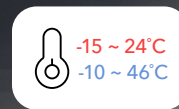
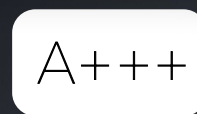

- 3D I-See senzor
- Area funkcija
- Prepoznavanje korisnika
- Econo-cool funkcija
- Automatska dvostruka krilca
- Tjedni tajmer
- Samodijagnoza
- Replace Tehnologija
- Automatsko prebacivanje načina rada
- Dvostruki premaz
- I-Save način rada
- Plasma Quad plus funkcija
- Noćni način rada

MODEL	UČINAK (W)		SEER / SCOP ENER. KLASA	DIMENZIJE V/Š/D (mm)	CIJENA (€)		
	HLADNJE	GRIJANJE			VPC	MPC	
CRVENI MODELI							
MSZ-LN25VGR	2500	3200	10,5 / 5,2	307 / 890 / 233	793,31	1.769,82	2.212,28
MUZ-LN25VG	(1000-3500)	(800-5400)	(A+++ / A+++)	550 / 800 / 285	976,51		
MSZ-LN35VGR	3500	4000	9,5 / 5,1	307 / 890 / 233	939,23	2.145,92	2.682,40
MUZ-LN35VG	(800-4000)	(1000-6300)	(A+++ / A+++)	550 / 800 / 285	1.206,69		
MSZ-LN50VGR	5000	6000	8,5 / 4,6	307 / 890 / 233	1.001,32	3.005,22	3.756,53
MUZ-LN50VG	(1000-6000)	(1000-8200)	(A+++ / A++)	714 / 800 / 285	2.003,90		
MSZ-LN60VGR	6100	6800	7,5 / 4,6	307 / 890 / 233	1.147,24	3.233,04	4.041,30
MUZ-LN60VG	(1400-6900)	(1800-9300)	(A++ / A++)	880 / 840 / 330	2.085,80		
BISERNO BIJELE MODELI							
MSZ-LN25VGW	2500	3200	10,5 / 5,2	307 / 890 / 233	793,31	1.769,82	2.212,28
MUZ-LN25VG	(1000-3500)	(800-5400)	(A+++ / A+++)	550 / 800 / 285	976,51		
MSZ-LN35VGW	3500	4000	9,5 / 5,1	307 / 890 / 233	939,23	2.145,92	2.682,40
MUZ-LN35VG	(800-4000)	(1000-6300)	(A+++ / A+++)	550 / 800 / 285	1.206,69		
MSZ-LN50VGW	5000	6000	8,5 / 4,6	307 / 890 / 233	1.001,32	3.005,22	3.756,53
MUZ-LN50VG	(1000-6000)	(1000-8200)	(A+++ / A++)	714 / 800 / 285	2.003,90		
MSZ-LN60VGW	6100	6800	7,5 / 4,6	307 / 890 / 233	1.147,24	3.233,04	4.041,30
MUZ-LN60VG	(1400-6900)	(1800-9300)	(A++ / A++)	880 / 840 / 330	2.085,80		
CRNI MODELI							
MSZ-LN25VGB	2500	3200	10,5 / 5,2	307 / 890 / 233	793,31	1.769,82	2.212,28
MUZ-LN25VG	(1000-3500)	(800-5400)	(A+++ / A+++)	550 / 800 / 285	976,51		
MSZ-LN35VGB	3500	4000	9,5 / 5,1	307 / 890 / 233	939,23	2.145,92	2.682,40
MUZ-LN35VG	(800-4000)	(1000-6300)	(A+++ / A+++)	550 / 800 / 285	1.206,69		
MSZ-LN50VGB	5000	6000	8,5 / 4,6	307 / 890 / 233	1.001,32	3.005,22	3.756,53
MUZ-LN50VG	(1000-6000)	(1000-8200)	(A+++ / A++)	714 / 800 / 285	2.003,90		
MSZ-LN60VGB	6100	6800	7,5 / 4,6	307 / 890 / 233	1.147,24	3.233,04	4.041,30
MUZ-LN60VG	(1400-6900)	(1800-9300)	(A++ / A++)	880 / 840 / 330	2.085,80		
BIJELE MODELI							
MSZ-LN25VGW	2500	3200	10,5 / 5,2	307 / 890 / 233	676,91	1.653,42	2.066,78
MUZ-LN25VG	(1000-3500)	(800-5400)	(A+++ / A+++)	550 / 800 / 285	976,51		
MSZ-LN35VGW	3500	4000	9,5 / 5,1	307 / 890 / 233	787,06	1.993,75	2.492,19
MUZ-LN35VG	(800-4000)	(1000-6300)	(A+++ / A+++)	550 / 800 / 285	1.206,69		
MSZ-LN50VGW	5000	6000	8,5 / 4,6	307 / 890 / 233	826,01	2.829,91	3.537,39
MUZ-LN50VG	(1000-6000)	(1000-8200)	(A+++ / A++)	714 / 800 / 285	2.003,90		
MSZ-LN60VGW	6100	6800	7,5 / 4,6	307 / 890 / 233	951,62	3.037,42	3.796,78
MUZ-LN60VG	(1400-6900)	(1800-9300)	(A++ / A++)	880 / 840 / 330	2.085,80		

Uključeno: bežični upravljač

CJEVOVOD	SNAGA (kW)			
	2,5	3,5	5,0	6,1
Max. visinska razlika [m]	12	12	12	15
Max. dužina instalacije [m]	20	20	30	30
Promjer cijevi tekuće faze [mm]	6,35	6,35	6,35	6,35
Promjer cijevi plinovite faze [mm]	9,52	9,52	9,52	12,7



MSZ-EF

KIRIGAMINE ZEN

- Econo-cool funkcija
- Automatsko zakretanje lopatica
- Automatska brzina ventilatora
- Automatsko prebacivanje načina rada
- Silver-ion filter
- Filter za pročišćavanje zraka
- Tjedni tajmer
- Samodijagnoza
- Hlađenje pri niskim temperaturama
- I-Save funkcija

MODEL	UČINAK (W)		SEER / SCOP ENER. KLASA	DIMENZIJE V / Š / D (mm)	CIJENA (€)	
	HLADENJE	GRIJANJE			VPC	MPC
SREBRNI MODELI						
MSZ-EF25VES	2500	3200	9,1/4,7	299 / 895 / 195	604,27	1.366,11
MUZ-EF25VG	(900-3400)	(1000-4200)	(A+++/A++)	550 / 800 / 285	761,84	
MSZ-EF35VES	3500	4000	8,8/4,6	299 / 895 / 195	684,53	1.606,99
MUZ-EF35VG	(1100-4000)	(1300-5100)	(A+++/A++)	550 / 800 / 285	922,46	
MSZ-EF42VES	4200	5400	7,9/4,6	299 / 895 / 195	775,59	2.079,57
MUZ-EF42VG	(900-4600)	(1300-6300)	(A+++/A++)	550 / 800 / 285	1.303,98	
MSZ-EF50VES	5000	5800	7,5/4,5	299 / 895 / 195	848,32	2.527,70
MUZ-EF50VG	(1400-5400)	(1400-7500)	(A++/A+)	714 / 800 / 285	1.679,38	
CRNI MODELI						
MSZ-EF25VEB	2500	3200	9,1/4,7	299 / 895 / 195	554,70	1.316,54
MUZ-EF25VB	(900-3400)	(1000-4200)	(A+++/A++)	550 / 800 / 285	761,84	
MSZ-EF35VEB	3500	4000	8,8/4,6	299 / 895 / 195	633,53	1.555,99
MUZ-EF35VB	(1100-4000)	(1300-5100)	(A+++/A++)	550 / 800 / 285	922,46	
MSZ-EF42VEB	4200	5400	7,9/4,6	299 / 895 / 195	723,07	2.027,05
MUZ-EF42VB	(900-4600)	(1300-6300)	(A+++/A++)	550 / 800 / 285	1.303,98	
MSZ-EF50VEB	5000	5800	7,5/4,5	299 / 895 / 195	801,91	2.481,29
MUZ-EF50VB	(1400-5400)	(1400-7500)	(A++/A+)	714 / 800 / 285	1.679,38	
BIJELI MODELI						
MSZ-EF25VEW	2500	3200	9,1/4,7	299 / 895 / 195	554,70	1.316,54
MUZ-EF25VW	(900-3400)	(1000-4200)	(A+++/A++)	550 / 800 / 285	761,84	
MSZ-EF35VEW	3500	4000	8,8/4,6	299 / 895 / 195	633,53	1.555,99
MUZ-EF35VW	(1100-4000)	(1300-5100)	(A+++/A++)	550 / 800 / 285	922,46	
MSZ-EF42VEW	4200	5400	7,9/4,6	299 / 895 / 195	723,07	2.027,05
MUZ-EF42VW	(900-4600)	(1300-6300)	(A+++/A++)	550 / 800 / 285	1.303,98	
MSZ-EF50VEW	5000	5800	7,5/4,5	299 / 895 / 195	801,91	2.481,29
MUZ-EF50VW	(1400-5400)	(1400-7500)	(A++/A+)	714 / 800 / 285	1.679,38	

Uključeno: bežični upravljač

CJEVOVOD	SNAGA (kW)			
	2,5	3,5	4,2	5,0
Max. visinska razlika [m]	12	12	12	15
Max. dužina instalacije [m]	20	20	20	30
Promjer cijevi tekuće faze [mm]	6,35	6,35	6,35	6,35
Promjer cijevi plinovite faze [mm]	9,52	9,52	9,52	9,52

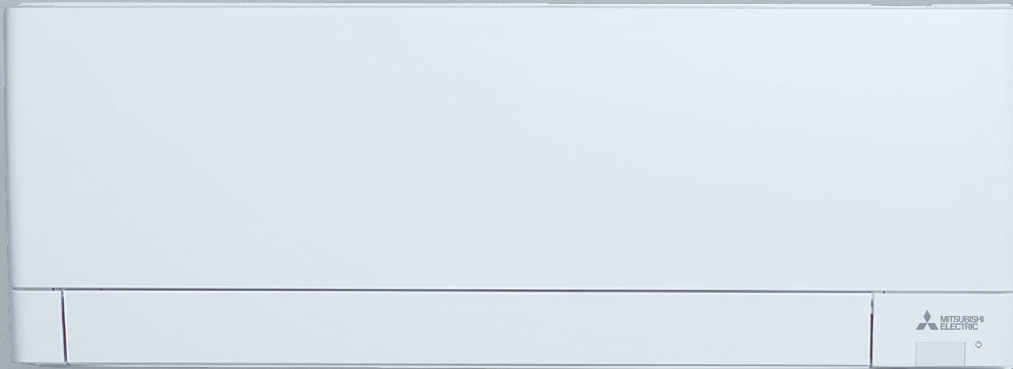

MSZ-AY

- Econo cool funkcija
- Noćni način rada
- I-Save funkcija
- Automatsko prebacivanje načina rada
- Samodijagnoza
- Hlađenje pri niskim temperaturama
- Dvostruka krilca



A+++

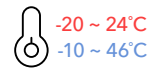

MODEL	UČINAK (W)		SEER / SCOP ENER. KLASA	DIMENZIJE V / Š / D (mm)	CIJENA (€)	
	HLADENJE	GRIJANJE			VPC	MPC
Verzija s Plasma quad filterom						
MSZ-AY20VGKP-E1	2000	2500	8.6/4.2	250/760/199	510,70	
MUZ-AY20VG-E1	(600 - 2700)	(500 - 3500)	A+++ / A+	500/800/285	650,91	1.161,61 1.452,01
MSZ-AY25VGKP	2500	3200	8.7/4.8	299/798/245	523,32	
MUZ-AY25VG	(900 - 3400)	(1000 - 4100)	A+++ / A++	550/800/285	667,91	1.191,23 1.489,04
MSZ-AY35VGKP	3500	4000	8.7/4.7	299/798/245	578,42	
MUZ-AY35VG	(1100 - 3800)	(1300 - 4600)	A+++ / A++	550/800/285	767,31	1.345,73 1.682,16
MSZ-AY42VGKP	4200	5200	7.9/4.7	299/798/245	666,80	
MUZ-AY42VG	(900 - 4500)	(1300 - 6000)	A++ / A++	550/800/285	1.072,42	1.739,22 2.174,03
MSZ-AY50VGKP	5000	5500	7.5/4.7	299/798/245	726,04	
MUZ-AY50VG	(1400 - 5400)	(1400 - 7300)	A++ / A++	714/800/285	1.298,42	2.024,46 2.530,58

Uključeno: bežični upravljač

CJEVOVOD	UČINAK (kW)			
	2,5	3,5	4,2	5,0
Max. visinska razlika [m]	12	12	12	12
Max. duljina instalacije [m]	20	20	20	20
Promjer cijevi tekuće faze [mm]	6,35	6,35	6,35	6,35
Promjer cijevi plinovite faze [mm]	9,52	9,52	9,52	9,52



MSZ-AP

- Tihi rad s niskom razinom buke
- Automatska dvostruka krilca
- Tjedni tajmer
- Samodijagnoza
- Replace Tehnologija
- Automatsko prebacivanje načina rada
- I-Save način rada

MODEL	UČINAK (W)		SEER / SCOP ENER. KLASA	DIMENZIJE V / Š / D (mm)	CIJENA (€)	
	HLADENJE	GRIJANJE			VPC	MPC
MSZ-AP60VG	6100	6800	7,4 / 4,6	325 / 1100 / 257	663,30	
MUZ-AP60VG	(1400-7300)	(2000-8600)	(A++ / A++)	714 / 800 / 285	1.403,85	2.067,15 2.583,94
MSZ-AP71VG	7100	8100	7,2 / 4,4	325 / 1100 / 257	767,15	
MUZ-AP71VG	(2000-8700)	(2200-10300)	(A++ / A+)	800 / 840 / 330	1.697,76	2.464,91 3.081,14

Ukjučeno: bežični upravljač

CJEVOVOD	SNAGA (KW)	
	6,0	7,1
Max. visinska razlika [m]	15	15
Max. dužina instalacije [m]	30	30
Promjer cijevi tekuće faze [mm]	6,35	6,35
Promjer cijevi plinovite faze [mm]	12,7	12,7

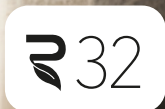

A++

 -15 ~ 24°C
-10 ~ 46°C

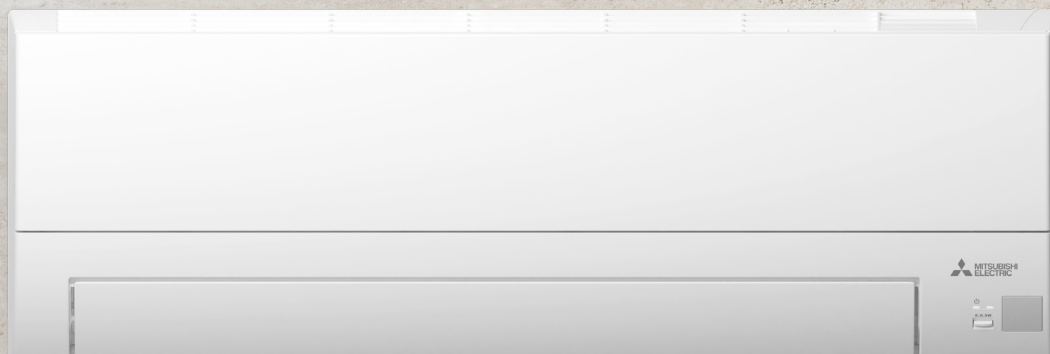

MSZ-BT

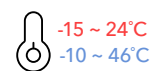
A++

- V Blocking filter
- Econo Cool funkcija
- Automatski način rada ventilatora
- Samodijagnoza
- Automatsko zakretanje krilaca
- Filter za pročišćavanje zraka
- Noćni način rada

MODEL	UČINAK (W)		SEER / SCOP ENER. KLASA	DIMENZIJE V / Š / D (mm)	CIJENA (€)	
	HLADENJE	GRIJANJE			VPC	MPC
Napajanje: 1 Ph / 230 V / 50 Hz						
MSZ-BT20VGK-E3	2000	2500	8.1 / 4.3	280 / 838 / 235	326,64	
MUZ-BT20VG-E2	(500-2900)	(700-3200)	A++ / A+	538 / 699 / 249	523,75	850,39 1.062,99
MSZ-BT25VGK-E3	2500	3150	8.1 / 4.6	280 / 838 / 235	338,04	
MUZ-BT25VG-E2	(500-3000)	(700-3500)	A++ / A++	538 / 699 / 249	534,30	872,34 1.090,43
MSZ-BT35VGK-E3	3500	3600	6.8 / 4.6	280 / 838 / 235	378,13	
MUZ-BT35VG-E2	(900-3500)	(900-4100)	A++ / A++	538 / 699 / 249	611,59	989,72 1.237,15
MSZ-BT50VGK-E3	5000	5400	6.6 / 4.4	280 / 838 / 235	467,89	
MUZ-BT50VG-E2	(1300-5000)	(1400-6500)	A++ / A+	550 / 800 / 285	977,14	1.445,03 1.806,29

Uključeno: bežični upravljač

CJEVOVOD	UČINAK (kW)			
	2,5	3,5	4,2	5,0
Max. visinska razlika [m]	12	12	12	12
Max. duljina instalacije [m]	20	20	20	20
Promjer cijevi tekuće faze [mm]	6,35	6,35	6,35	6,35
Promjer cijevi plinovite faze [mm]	9,52	9,52	9,52	12,7



MSZ-HR

- Poboljšana učinkovitost
- Tihi rad s niskom razinom buke
- Econo Cool funkcija
- Samodijagnoza
- Automatski način rada ventilatora

 MOGUĆNOST
UGRADNJE

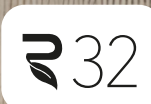
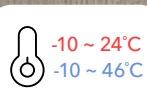
A++

R32

 -10 ~ 24°C
-10 ~ 46°C

MODEL	UČINAK (W)		SEER / SCOP ENER. KLASA	DIMENZIJE V / Š / D (mm)	CIJENA (€)	
	HLADNJE	GRIJANJE			VPC	MPC
Bez WiFi sučelja						
MSZ-HR25VF	2500	3150	6,2 / 4,3	280 / 838 / 228	260,66	
MUZ-HR25VF	(500-2900)	(700-3500)	(A++ / A+)	538 / 699 / 249	375,55	636,21
MSZ-HR35VF	3400	3600	6,2 / 4,3	280 / 838 / 228	293,01	
MUZ-HR35VF	(900-3400)	(900-3700)	(A++ / A+)	538 / 699 / 249	437,40	730,41
MSZ-HR42VF	4200	4700	6,5 / 4,3	280 / 838 / 228	416,71	
MUZ-HR42VF	(1100-4600)	(900-5400)	(A++ / A+)	550 / 800 / 285	641,94	1.058,65
MSZ-HR50VF	5000	5400	6,5 / 4,3	280 / 838 / 228	452,04	
MUZ-HR50VF	(1300-5000)	(1400-6500)	(A++ / A+)	550 / 800 / 285	734,66	1.186,70
MSZ-HR60VF	6100	6800	7,2/4,5	305 / 923 / 262	480,90	
MUZ-HR60VF	(1700-7100)	(1500-8500)	(A++/A+)	714 / 800 / 285	1.032,68	1.513,58
MSZ-HR71VF	7100	8100	7,0/4,3	305 / 923 / 262	550,61	
MUZ-HR71VF	(1800-7300)	(1500-9000)	(A++/A+)	714 / 800 / 285	1.180,44	1.731,05
Uključeno WiFi sučelje						
MSZ-HR25VF(K)	2500	3150	6,2 / 4,3	280 / 838 / 228	313,75	
MUZ-HR25VF	(500-2900)	(700-3500)	(A++ / A+)	538 / 699 / 249	375,55	689,30
MSZ-HR35VF(K)	3400	3600	6,2 / 4,3	280 / 838 / 228	353,69	
MUZ-HR35VF	(900-3400)	(900-3700)	(A++ / A+)	538 / 699 / 249	437,40	791,09
MSZ-HR42VF(K)	4200	4700	6,5 / 4,3	280 / 838 / 228	483,75	
MUZ-HR42VF	(1100-4600)	(900-5400)	(A++ / A+)	550 / 800 / 285	641,94	1.125,69
MSZ-HR50VF(K)	5000	5400	6,5 / 4,3	280 / 838 / 228	516,37	
MUZ-HR50VF	(1300-5000)	(1400-6500)	(A++ / A+)	550 / 800 / 285	734,66	1.251,03
MSZ-HR60VF(K)	6100	6800	7,2/4,5	305 / 923 / 262	547,15	
MUZ-HR60VF	(1700-7100)	(1500-8500)	(A++/A+)	714 / 800 / 285	1.032,68	1.579,83
MSZ-HR71VF(K)	7100	8100	7,0/4,3	305 / 923 / 262	605,04	
MUZ-HR71VF	(1800-7300)	(1500-9000)	(A++/A+)	714 / 800 / 285	1.180,44	1.785,48

Uključeno: bežični upravljač

CJEVOVOD	SNAGA (kW)					
	2,5	3,4	4,2	5,0	6,1	7,1
Max. visinska razlika [m]	12	12	12	12	15	15
Max. dužina instalacije [m]	20	20	20	20	30	30
Promjer cijevi tekuće faze [mm]	6,35	6,35	6,35	6,35	6,35	6,35
Promjer cijevi plinovite faze [mm]	9,52	9,52	9,52	9,52	12,7	12,7



MSZ-DW

- V Blocking filter
- Econo Cool funkcija
- Automatski način rada ventilatora
- Samodijagnoza
- Automatsko zakretanje krilaca
- Filter za pročišćavanje zraka

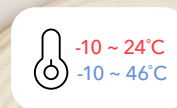
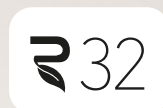
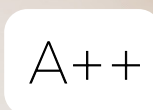

MODEL	UČINAK (W)		SEER/SCOP ENER. KLASA	DIMENZIJE V / Š / D (mm)	CIJENA (€)		
	HLADENJE	GRIJANJE			VPC	MPC	
MSZ-DW25VF	2500	3150	6,2 / 4,3 (A++/A+)	290 / 799 / 232	249,15	608,19	760,24
MUZ-DW25VF	(500-2900)	(700-3500)		538 / 699 / 249	359,04		
MSZ-DW35VF	3400	3600	6,2 / 4,3 (A++/A+)	290 / 799 / 232	278,28	701,72	877,15
MUZ-DW35VF	(900-3400)	(900-3700)		538 / 699 / 249	423,44		
MSZ-DW50VF	5000	5400	6,5 / 4,3 (A++/A+)	290 / 799 / 232	416,05	1.103,21	1.379,01
MUZ-DW50VF	(1300-5000)	(1400-6500)		550 / 800 / 285	687,16		

Uključeno: bežični upravljač

CJEVOVOD	UČINAK (kW)		
	2,5	3,4	5,0
Max. visinska razlika [m]	12	12	15
Max. duljina instalacije [m]	20	20	20
Promjer cijevi tekuće faze [mm]	6,35	6,35	6,35
Promjer cijevi plinovite faze [mm]	9,52	9,52	9,52

PODNA IZVEDBA

DC INVERTER SERIJA

MFZ-KT

- Econo-cool funkcija
- Automatsko zakretanje lopatica
- Automatska brzina ventilatora
- Tjedni tajmer
- I-Save funkcija
- Silver-ion
- Filter za pročišćavanje zraka
- Automatsko prebacivanje načina rada

MODEL	UČINAK (W)		SEER / SCOP ENER. KLASA	DIMENZIJE V / Š / D (mm)	CIJENA (€)	
	HLADNJE	GRIJANJE			VPC	MPC
Bez Wi-Fi sučelja, mogućnost ugradnje						
MFZ-KT25VG	2500	3400	6,5/4,2	600 / 750 / 215	924,68	
SUZ-M25VAR2.TH	(1600 - 3200)	(1300-4200)	(A++/A+)	550 / 800 / 285	877,08	1.801,76 2.252,20
MFZ-KT35VG	3500	4300	6,6/4,4	600 / 750 / 215	983,81	
SUZ-M35VAR2.TH	(900-3900)	(1100-5000)	(A++/A+)	550 / 800 / 285	997,67	1.981,48 2.476,85
MFZ-KT50VG	5000	6000	6,8/4,2	600 / 750 / 215	1.567,31	
SUZ-M50VAR2.TH	(1200-5600)	(1500-7200)	(A++/A+)	714 / 800 / 285	1.347,20	2.914,51 3.643,14
MFZ-KT60VG	6100	7000	6,2/4,1	600 / 750 / 215	1.802,34	
SUZ-M60VAR2.TH	(1700-6300)	(1600-8000)	(A++/A+)	880 / 840 / 330	1.451,26	3.253,60 4.067,00
Uključeno Wi-Fi sučelje						
MFZ-KT25VGK	2500	3400	6,5/4,2	600 / 750 / 215	970,92	
SUZ-M25VAR2.TH	(1600 - 3200)	(1300-4200)	(A++/A+)	550 / 800 / 285	877,08	1.848,00 2.310,00
MFZ-KT35VGK	3500	4300	6,6/4,4	600 / 750 / 215	1.033,00	
SUZ-M35VAR2.TH	(900-3900)	(1100-5000)	(A++/A+)	550 / 800 / 285	997,67	2.030,67 2.538,34
MFZ-KT50VGK	5000	6000	6,8/4,2	600 / 750 / 215	1.635,67	
SUZ-M50VAR2.TH	(1200-5600)	(1500-7200)	(A++/A+)	714 / 800 / 285	1.347,20	2.982,87 3.728,59
MFZ-KT60VGK	6100	7000	6,2/4,1	600 / 750 / 215	1.856,41	
SUZ-M60VAR2.TH	(1700-6300)	(1600-8000)	(A++/A+)	880 / 840 / 330	1.451,26	3.307,67 4.134,59
Uključeno: bežični upravljač						

A++

 -10 ~ 24°C
 -10 ~ 46°C

M25, M35

 -10 ~ 24°C
 -15 ~ 46°C

M50, M60
R32

CJEVOVOD	SNAGA (kW)			
	2,5	3,5	5,0	6,1
Max. visinska razlika [m]	12	12	30	30
Max. dužina instalacije [m]	20	20	30	30
Promjer cijevi tekuće faze [mm]	6,35	6,35	6,35	6,35
Promjer cijevi plinovite faze [mm]	9,52	9,52	12,7	15,8



SFZ-M

- Automatska brzina ventilatora
- Samodijagnoza
- Automatsko prebacivanje načina rada
- Tjedni tajmer
- Kompaktan dizajn

 MOGUĆNOST
UGRADNJE

A++

 -10 ~ 24°C
-10 ~ 46°C

M25, M35

 -10 ~ 24°C
-15 ~ 46°C

M50, M60



MODEL	UČINAK (W)		SEER / SCOP ENER. KLASA	DIMENZIJE V / Š / D (mm)	CIJENA (€)	
	HLADENJE	GRIJANJE			VPC	MPC
SFZ-M25VA.TH	2500	3200	6.1 / 4.0	615 (690) / 797 (700) / 200	654,31	
SUZ-M25VAR2.TH	(1500-3200)	(1200-4200)	(A++ / A+)	550 / 800 / 285	877,08	1.742,86 2.178,58
PAR-41MAA				120 / 120 / 14,5	211,47	
SFZ-M35VA.TH	3500	4100	6.1 / 4.1	615 (690) / 997 (900) / 200	718,71	
SUZ-M35VAR2.TH	(700-3900)	(1000-5000)	(A++ / A+)	550 / 800 / 285	997,67	1.927,85 2.409,81
PAR-41MAA				120 / 120 / 14,5	211,47	
SFZ-M50VA.TH	5000	6000	6.1 / 4.1	615 (690) / 997 (900) / 200	827,21	
SUZ-M50VAR2.TH	(1100-5600)	(1500-7200)	(A++ / A+)	714 / 800 / 285	1.347,20	2.385,88 2.982,35
PAR-41MAA				120 / 120 / 14,5	211,47	
SFZ-M60VA.TH	6100	7000	6.1 / 4.2	615 (690) / 1197 (1100) / 200	950,42	
SUZ-M60VAR2.TH	(1600-6300)	(1600-8000)	(A++ / A+)	880 / 840 / 330	1.451,26	2.613,15 3.266,44
PAR-41MAA				120 / 120 / 14,5	211,47	
SFZ-M71VA.TH	7100	8000	6.1 / 4.0	615 (690) / 1197 (1100) / 200	1.093,92	
SUZ-M71VAR1.TH	(1900-8100)	(2000-10200)	(A++ / A+)	880 / 840 / 330	1.713,38	3.018,77 3.773,46
PAR-41MAA				120 / 120 / 14,5	211,47	

CJEVOVOD	SNAGA (kW)			
	2,5	3,5	5,0	6,1
Max. visinska razlika [m]	12	12	30	30
Max. dužina instalacije [m]	20	20	30	30
Promjer cijevi tekuće faze [mm]	6,35	6,35	6,35	6,35
Promjer cijevi plinovite faze [mm]	9,52	9,52	12,7	15,8



KAZETNA IZVEDBA

1-SMJERNA - DC INVERTER SERIJA

MLZ-KP

- Automatsko zakretanje lopatica
- Dovod svježeg zraka
- Signal za provjeru filtera
- Dugotrajni filter
- Automatsko prebacivanje načina rada
- Auto restart
- Hlađenje pri niskim temperaturama
- 24 satni tajmer
- Samodijagnoza
- Horizontalni položaj krilaca

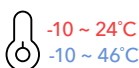
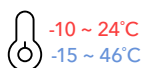
A++

M25, M35

M50

R32

MODEL	UČINAK (W)		SEER / SCOP ENER. KLASA	DIMENZIJE V / Š / D (mm)	CIJENA (€)	
	HLAĐENJE	GRIJANJE			VPC	MPC
Bežični daljinski upravljač i maska MLP-444W uključeni u cijenu.						
MLZ-KP25VG-E1				185 / 1102 / 360	812,72	
MLP-444W	2500 (1400-3200)	3200 (1400-4200)	6,2 / 4,4 (A++ / A+)	24 / 1200 / 424	258,02	1.947,82 2.434,78
SUZ-M25VAR2.TH				550 / 800 / 285	877,08	
MLZ-KP35VG-E1				185 / 1102 / 360	967,23	
MLP-444W	3500 (800-3900)	4100 (1100-4900)	7,0 / 4,6 (A++ / A++)	24 / 1200 / 424	258,02	2.222,92 2.778,65
SUZ-M35VAR2.TH				550 / 800 / 285	997,67	
MLZ-KP50VG-E1				185 / 1102 / 360	1.285,41	
MLP-444W	5000 (1700-5600)	6000 (1700-7200)	6,7 / 4,3 (A++ / A+)	24 / 1200 / 424	258,02	2.890,63 3.613,29
SUZ-M50VAR2.TH				714 / 800 / 285	1.347,20	

CJEVOVOD	SNAGA (kW)		
	2,5	3,5	5,0
Max. visinska razlika [m]	12	12	30
Max. dužina instalacije [m]	20	20	30
Promjer cijevi tekuće faze [mm]	6,35	6,35	6,35
Promjer cijevi plinovite faze [mm]	9,52	9,52	12,7



KAZETNA IZVEDBA

4-SMJERNA - DC INVERTER SERIJA

SLZ-M

- Automatsko zakretanje lopatica
- Dovod svježeg zraka
- Signal za provjeru filtera
- Dugotrajni filter
- Automatsko prebacivanje načina rada
- Auto restart
- Hlađenje pri niskim temperaturama
- 24 satni tajmer
- Samodijagnoza
- Vertikalni položaj krilaca

 MOGUĆNOST
UGRADNJE

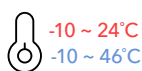
A++

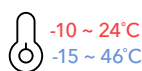
 -10 ~ 24°C
-10 ~ 46°C

M25, M35

 -10 ~ 24°C
-15 ~ 46°C

M50, M60

R32

MODEL	UČINAK (W)		SEER / SCOP ENER. KLASA	DIMENZIJE V / S / D (mm)	CIJENA (€)	
	HLADENJE	GRIJANJE			VPC	MPC
Žičani daljinski upravljač PAR-40MAA i ukrasna maska SLP-2FA uključeni u cijenu.						
SLZ-M25FA2.TH				245 / 570 / 570	531,00	
PAR-41MAA	2500	3200	6,3 / 4,3	120 / 120 / 14,5	211,47	1.816,26 2.270,33
SLP-2FAL	(1400-3200)	(1300-4200)	(A++ / A+)	10 / 625 / 625	196,71	
SUZ-M25VAR2.TH				550 / 800 / 285	877,08	
SLZ-M35FA2.TH				245 / 570 / 570	603,08	
PAR-41MAA	3500	4000	6,7 / 4,3	120 / 120 / 14,5	211,47	2.008,93 2.511,16
SLP-2FAL	(700-3900)	(1000-5000)	(A++ / A+)	10 / 625 / 625	196,71	
SUZ-M35VAR2.TH				550 / 800 / 285	997,67	
SLZ-M50FA2.TH				245 / 570 / 570	762,05	
PAR-41MAA	4600	5000	6,3 / 4,2	120 / 120 / 14,5	211,47	2.517,43 3.146,79
SLP-2FAL	(1000-5200)	(1300-5500)	(A++ / A+)	10 / 625 / 625	196,71	
SUZ-M50VAR2.TH				714 / 800 / 285	1.347,20	
SLZ-M60FA2.TH				245 / 570 / 570	808,45	
PAR-41MAA	5700	6400	6,2 / 4,1	120 / 120 / 14,5	211,47	2.667,89 3.334,86
SLP-2FAL	(1500-6300)	(1600-7300)	(A++ / A+)	10 / 625 / 625	196,71	
SUZ-M60VAR2.TH				880 / 840 / 330	1.451,26	
Bežični daljinski upravljač i maska SLP-2FALM uključeni u cijenu.						
SLZ-M25FA2.TH				245 / 570 / 570	531,00	
SLP-2FALM	2500	3200	6,3 / 4,3	10 / 625 / 625	255,08	1.663,16 2.078,95
SUZ-M25VAR2.TH				550 / 800 / 285	877,08	
SLZ-M35FA2.TH				245 / 570 / 570	603,08	
SLP-2FALM	3500	4000	6,7 / 4,3	10 / 625 / 625	255,08	1.855,83 2.319,79
SUZ-M35VAR2.TH	(700-3900)	(1000-5000)	(A++ / A+)	550 / 800 / 285	997,67	
SLZ-M50FA2.TH				245 / 570 / 570	762,05	
SLP-2FALM	4600	5000	6,3 / 4,2	10 / 625 / 625	255,08	2.364,33 2.955,41
SUZ-M50VAR2.TH	(1000-5200)	(1300-5500)	(A++ / A+)	714 / 800 / 285	1.347,20	
SLZ-M60FA2.TH				245 / 570 / 570	808,45	
SLP-2FALM	5700	6400	6,2 / 4,1	10 / 625 / 625	255,08	2.514,79 3.143,49
SUZ-M60VAR2.TH	(1500-6300)	(1600-7300)	(A++ / A+)	880 / 840 / 330	1.451,26	

Ukjučeno: pumpa za odvod kondenzata

CJEVOVD	SNAGA (kW)			
	2,5	3,5	4,6	5,7
Max. visinska razlika [m]	12	12	30	30
Max. dužina instalacije [m]	20	20	30	30
Promjer cijevi tekuće faze [mm]	6,35	6,35	6,35	6,35
Promjer cijevi plinovite faze [mm]	9,52	9,52	12,7	15,88

KANALSKA IZVEDBA

DC INVERTER SERIJA

SEZ-M

- Automatsko prebacivanje načina rada
- Automatsko zakretanje lopatica
- Auto restart
- Hlađenje pri niskim temperaturama
- 24 satni tajmer
- Samodijagnoza

MODEL	UČINAK (W)		SEER / SCOP ENER. KLASA	DIMENZIJE V / Š / D (mm)	CIJENA (€)	
	HLADENJE	GRIJANJE			VPC	MPC
SEZ-M25DA2.TH				200 / 790 / 700	568,12	
SUZ-M25VAR2.TH	2500 (1400-3200)	2900 (1300-4200)	6,0 / 4,0 (A+ / A+)	550 / 800 / 285	877,08	1.656,67 2.070,84
PAR-41MAA				120 / 120 / 14,5	211,47	
SEZ-M35DA2.TH				200 / 990 / 700	620,96	
SUZ-M35VAR2.TH	3500 (700-3900)	4200 (1100-5000)	6,0 / 4,1 (A+ / A+)	550 / 800 / 285	997,67	1.830,10 2.287,63
PAR-41MAA				120 / 120 / 14,5	211,47	
SEZ-M50DA2.TH				200 / 990 / 700	679,54	
SUZ-M50VAR2.TH	5000 (1100-5600)	6000 (1500-7200)	6,0 / 4,0 (A+ / A+)	714 / 800 / 285	1.347,20	2.238,21 2.797,76
PAR-41MAA				120 / 120 / 14,5	211,47	
SEZ-M60DA2.TH				200 / 1190 / 700	802,53	
SUZ-M60VAR2.TH	6100 (1600-6300)	7400 (1600-8000)	5,5 / 4,2 (A / A+)	880 / 840 / 330	1.451,26	2.465,26 3.081,58
PAR-41MAA				120 / 120 / 14,5	211,47	
SEZ-M71DA2.TH				200 / 1190 / 700	1.088,98	
SUZ-M71VAR1.TH	7100 (2200-8100)	8000 (2000-10200)	5,5 / 3,9 (A / A)	880 / 840 / 330	1.713,38	3.013,83 3.767,29
PAR-41MAA				120 / 120 / 14,5	211,47	

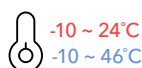
A++

M25, M35

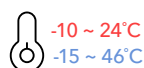

M50, M60, M71



CJEVOVOD	SNAGA (kW)				
	2,5	3,5	5,1	5,6	7,1
Max. visinska razlika [m]	12	12	30	30	30
Max. dužina instalacije [m]	20	20	30	30	30
Promjer cijevi tekuće faze [mm]	6,35	6,35	6,35	6,35	9,52
Promjer cijevi plinovite faze [mm]	9,52	9,52	12,7	15,88	15,88

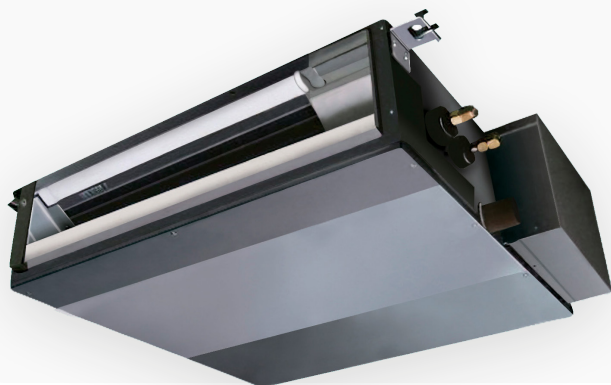

MULTI SUSTAVI

STANDARD DC INVERTER SERIJA

VANJSKE JEDINICE

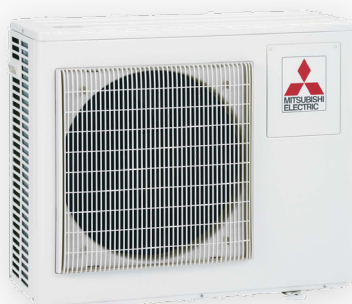
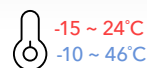

MODEL	MEDIJ	UČINAK (W)		SEER / SCOP ENER. KLASA	DIMENZIJE V / Š / D (mm)	CIJENA (€)	
		HLADENJE	GRIJANJE			VPC	MPC
MXZ-2HA40VF	R32	4000 (1100-4300)	4300 (1000-4800)	8,12 / 4,3 (A++ / A+)	550 / 800 / 285	1.170,21	1.462,76
MXZ-2HA50VF	R32	5000 (1100-5400)	6000 (1000-6400)	7,78 / 4,3 (A++ / A+)	550 / 800 / 285	1.379,42	1.724,28

 Mogućnost spajanja **do 2 unutarnje jedinice**

MODEL	MEDIJ	UČINAK (W)		SEER / SCOP ENER. KLASA	DIMENZIJE V / Š / D (mm)	CIJENA (€)	
		HLADENJE	GRIJANJE			VPC	MPC
MXZ-3HA50VF	R32	5000 (2900-6500)	6000 (2600-7500)	7,26 / 4,02 (A++ / A+)	710 / 840 / 330	1.771,91	2.214,89

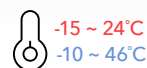
 Mogućnost spajanja **do 3 unutarnje jedinice**



ODGOVARAJUĆA UNUTARNJA JEDINICA



MODEL	DIMENZIJE V / Š / D (mm)	CIJENA (€)	
		VPC	MPC
Za vanjske jedinice MXZ-2HA / MXZ-3HA			
MSZ-DW25VF	290 / 799 / 232	249,15	311,44
MSZ-DW35VF	290 / 799 / 232	278,28	347,85
MSZ-HR25VF	280 / 838 / 228	260,66	325,83
MSZ-HR35VF	280 / 838 / 228	293,01	366,26
MSZ-HR42VF	280 / 838 / 228	416,71	520,89
MSZ-HR50VF	280 / 838 / 228	452,04	565,05
MSZ-HR25VFK	280 / 838 / 228	313,75	392,19
MSZ-HR35VFK	280 / 838 / 228	353,69	442,11
MSZ-HR42VFK	280 / 838 / 228	483,75	604,69
MSZ-HR50VFK	280 / 838 / 228	516,37	645,46



MULTI SUSTAVI

POWER DC INVERTER SERIJA / VANJSKE JEDINICE

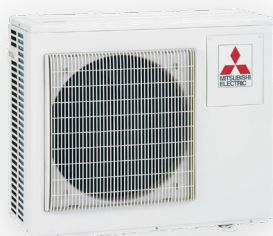

 -15 ~ 24°C
 -10 ~ 46°C

MODEL	MEDIJ	UČINAK (W)		EER / COP ENER. KLASA	DIMENZIJE V / Š / D (mm)	CIJENA (€)	
		HLADENJE	GRIJANJE			VPC	MPC
MXZ-2F33VF3	R32	3300 (1100-3800)	4000 (1000-4100)	6,1 / 4,0 (A++ / A+)	550 / 800 / 285	1.155,37	1.444,21
MXZ-2F42VF3	R32	4200 (1100-4400)	4500 (1000-4800)	8,7 / 4,6 (A+++ / A++)	550 / 800 / 285	1.505,47	1.881,84
MXZ-2F53VF3	R32	5300 (1100-5600)	6400 (1000-7000)	8,6 / 4,6 (A+++ / A++)	550 / 800 / 285	1.542,42	1.928,03

Mogućnost spajanja do 2 unutarnje jedinice



 -15 ~ 24°C
 -10 ~ 46°C

MODEL	MEDIJ	UČINAK (W)		EER / COP ENER. KLASA	DIMENZIJE V / Š / D (mm)	CIJENA (€)	
		HLADENJE	GRIJANJE			VPC	MPC
MXZ-3F54VF3	R32	5400 (2900-6800)	7000 (2600-9000)	8,5 / 4,6 (A+++ / A++)	710 / 840 / 330	2.166,65	2.708,31
MXZ-3F68VF3	R32	6800 (2900-8400)	8600 (2600-10600)	7,9 / 4,1 (A++ / A+)	710 / 840 / 330	2.594,07	3.242,59



Mogućnost spajanja do 3 unutarnje jedinice



 -15 ~ 24°C
 -10 ~ 46°C

MODEL	MEDIJ	UČINAK (W)		EER / COP ENER. KLASA	DIMENZIJE V / Š / D (mm)	CIJENA (€)	
		HLADENJE	GRIJANJE			VPC	MPC
MXZ-4F72VF	R32	7200 (3700-8800)	8600 (3400-10700)	8,1 / 4,1 (A++ / A+)	710 / 840 / 330	2.956,94	3.696,18
MXZ-4F80VF	R32	8000 (3799 - 9000)	8800 (3400 - 11000)	7,6 / 4,1 (A++ / A+)	710 / 840 / 330	3.081,48	3.851,85
MXZ-4F83VF	R32	8300 (3700-9200)	9300 (3400-11600)	8,5 / 4,7 (A+++ / A++)	796 / 950 / 330	3.173,74	3.967,18

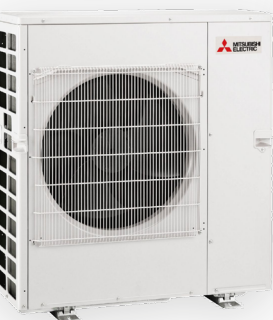
Mogućnost spajanja do 4 unutarnje jedinice



 -15 ~ 24°C
 -10 ~ 46°C

MODEL	MEDIJ	UČINAK (W)		EER / COP ENER. KLASA	DIMENZIJE V / Š / D (mm)	CIJENA (€)	
		HLADENJE	GRIJANJE			VPC	MPC
MXZ-5F102VF	R32	10200 (3900-11000)	10500 (4100-14000)	8,2 / 4,7 (A++ / A++)	796 / 950 / 330	3.481,40	4.351,75

Mogućnost spajanja do 5 unutarnjih jedinica



 -15 ~ 24°C
 -10 ~ 46°C

MODEL	MEDIJ	UČINAK (W)		EER / COP ENER. KLASA	DIMENZIJE V / Š / D (mm)	CIJENA (€)	
		HLADENJE	GRIJANJE			VPC	MPC
MXZ-6F120VF	R32	12000 (3500-14000)	14000 (3500-16500)	3,3 / 4,2 (A / A)	1048 / 950 / 330	4.303,96	5.379,95

Mogućnost spajanja do 6 unutarnjih jedinica

* Ako je vanjska jedinica iznad unutarnje jedinice, maksimalna visinska razlika iznosi 10m.

CJEVOVOD	SNAGA (kW)									
	3,3	4,2	5,3	5,4	6,8	7,2	8,3	10,2	12,2	
Max. visinska razlika [m]	10	15(10)*	15(10)*	15(10)*	15(10)*	15(10)*	15	15	15	
Max. dužina instalacije [m] (ukupno/pojedinačno)	20 / 15	30 / 20	30 / 20	50 / 25	60 / 25	60 / 25	70 / 25	80 / 25	80 / 25	

R410_A

 -20 ~ 15°C
 -5 ~ 52°C

 Mogućnost spajanja **do 8 unutarnjih jedinica**
 RAC serije koristeći **BRANCH BOX(ove)**

MODEL	UČINAK (W)		SEER / SCOP ENER. KLASA	DIMENZIJE V/Š/D (mm)	CIJENA (€)	
	HLADENJE	GRIJANJE			VPC	MPC
Napajanje: 1 Ph / 220 - 240 V / 50 Hz						
PUMY-SP112VKM	12500	14000	6,76 / 3,98 (A++ / A)	981 / 1050 / 330	4.005,75	5.007,19
PUMY-SP125VKM	14000	16000	6,74 / 3,93 (A++ / A)	981 / 1050 / 330	4.810,05	6.012,56
PUMY-SP140VKM	15500	16500	6,49 / 3,9 (A++ / A)	981 / 1050 / 330	5.281,50	6.601,88
Napajanje: 3 Ph / 380 - 415 V / 50 Hz						
PUMY-SP112YKM	12500	14000	6,76 / 3,98 (A++ / A)	981 / 1050 / 330	4.319,70	5.399,63
PUMY-SP125YKM	14000	16000	6,74 / 3,93 (A++ / A)	981 / 1050 / 330	4.898,25	6.122,81
PUMY-SP140YKM	15500	16500	6,49 / 3,9 (A++ / A)	981 / 1050 / 330	5.450,55	6.813,19



MODEL	UČINAK (W)		SEER / SCOP ENER. KLASA	DIMENZIJE V/Š/D (mm)	CIJENA (€)	
	HLADENJE	GRIJANJE			VPC	MPC
Napajanje: 1 Ph / 220 - 240 V / 50 Hz						
PUMY-P112VKM	12500	14000	6,55 / 4,64 (A++ / A++)	1338 / 1050 / 330	4.947,60	6.184,50
PUMY-P125VKM	14000	16000	6,6 / 4,63 (A++ / A++)	1338 / 1050 / 330	5.785,50	7.231,88
PUMY-P140VKM	15500	18000	6,25 / 4,42 (A++ / A+)	1338 / 1050 / 330	6.151,95	7.689,94
Napajanje: 3 Ph / 380 - 415 V / 50 Hz						
PUMY-P112YKM	12500	14000	6,55 / 4,64 (A++ / A++)	1338 / 1050 / 330	5.198,55	6.498,19
PUMY-P125YKM	14000	16000	6,6 / 4,63 (A++ / A++)	1338 / 1050 / 330	5.877,90	7.347,38
PUMY-P140YKM	15500	18000	6,25 / 4,42 (A++ / A+)	1338 / 1050 / 330	6.346,20	7.932,75
PUMY-P200YKM	22 400	25 000	5,45 / 4,21 (A / A+)	1338 / 1050 / 330	6.506,85	8.133,56

R32

 -20 ~ 15°C
 -5 ~ 52°C



MODEL	UČINAK (W)		SEER / SCOP ENER. KLASA	DIMENZIJE V/Š/D (mm)	CIJENA (€)	
	HLADENJE	GRIJANJE			VPC	MPC
Napajanje: 1 Ph / 220 - 240 V / 50 Hz						
PUMY-SM112VKM	12 500	14 000	8,19 / 4,96 (A++ / A++)	981 / 1050 / 330	4.192,00	5.240,00
PUMY-SM125VKM	14 000	16 000	8,09 / 4,87 (A++ / A++)	981 / 1050 / 330	4.545,00	5.681,25
PUMY-SM140VKM	15 500	17 500	7,94 / 4,85 (A++ / A++)	981 / 1050 / 330	5.060,00	6.325,00
Napajanje: 3 Ph / 380 - 415 V / 50 Hz						
PUMY-SM112YKM	12 500	14 000	8,19 / 4,96 (A++ / A++)	981 / 1050 / 330	5.160,00	6.450,00
PUMY-SM125YKM	14 000	16 000	8,09 / 4,87 (A++ / A++)	981 / 1050 / 330	5.565,00	6.956,25
PUMY-SM140YKM	15 500	17 500	7,94 / 4,85 (A++ / A++)	981 / 1050 / 330	5.745,00	7.181,25

MODEL	DODATNA OPREMA / OPIS	CIJENA (€)	
		VPC	MPC
PAC-SK60SA-E	Sigurnosni senzor za detekciju curenja rashladnog plina	189,40	236,75

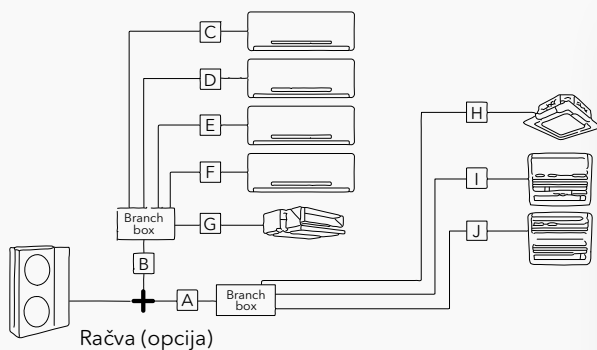

BRANCH BOX (RAZDJELNIK)		CIJENA (€)	
		VPC	MPC
PAC-MK34BC	do 3 unutarnje jedinice	746,86	933,58
PAC-MK54BC	do 5 unutarnjih jedinica	895,59	1.119,49
PAC-MMK40BC	do 4 unutarnje jedinice	956,58	1.195,73
PAC-MMK60BC	do 6 unutarnjih jedinica	1646,73	2.058,41

BAKRENA RAČVA		CIJENA (€)	
		VPC	MPC
MSDD-50BR-E	za spajanje branch Box-ova	71,37	89,21
MSDD-50AR-E	za spajanje branch Box-ova	74,37	92,96
MSDD-50AR2	za spajanje branch box-ova	120,91	151,14

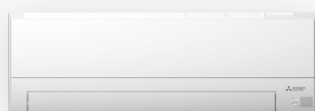

		PUMY SP MAX.	PUMY P MAX.
Ukupno cjevovoda	(A+B+C+D+E+F+G+H+I+J)	130m	150m
Vanjska jedinica - Branch box	(A+B)	55m	55m
Branch box - unutarnja jedinica	(C+D+E+F+G+H+I+J)	95m	95m
Unutarnja jedinica - Vanjska jedinica	pojedinačno (C,D,E,F,G,H,I,J)	25m	25m
Visinska razlika	Vanjska jedinica - Unutarnja jedinica*	50m	50m
	Branch box - Unutarnja jedinica	15m	15m
	Unutarnja jedinica - Unutarnja jedinica	12m	12m
Napomena	PUMY SP * U slučaju da je vanjska jedinica ispod razine unutarnjih jedinica: 40m PUMY P * U slučaju da je vanjska jedinica ispod razine unutarnjih jedinica: 30m		

**ODGOVARAJUĆE
UNUTARNJE JEDINCE**
ZIDNA IZVEDBA

MSZ-BT 20/25/35 VG

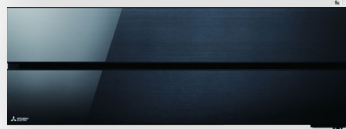
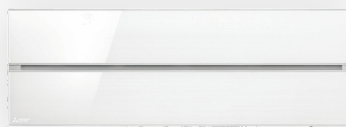
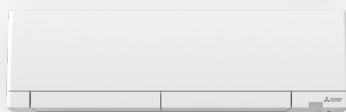
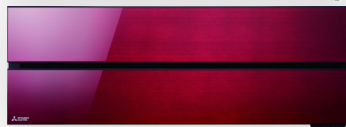

MSZ-AP

 MSZ-EF 25/35/42/50
WEB / VEW / VES

 MFZ-LN 25/35/50/60
VGW / VGB / VGR / VGV

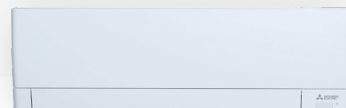
MSZ-RW



MSZ-AY

MODEL	DIMENZIJE V / Š / D (mm)	CIJENA (€)	
		VPC	MPC
MSZ-BT20VG(K)	280 / 838 / 235	326,64	408,30
MSZ-BT25VG(K)	280 / 838 / 235	338,04	422,55
MSZ-BT35VG(K)	280 / 838 / 235	378,13	472,66
MSZ-AP60VG(K)	325 / 1100 / 257	663,3	829,13
MSZ-AP71VG(K)	325 / 1100 / 257	767,15	958,94
MSZ-AY15VGKP-E1	250/760/199	487,65	609,56
MSZ-AY20VGKP-E1	250/760/199	510,7	638,38
MSZ-AY25VGKP-E1	299/798/245	523,32	654,15
MSZ-AY35VGKP-E1	299/798/245	578,42	723,03
MSZ-AY42VGKP-E1	299/798/245	666,80	833,50
MSZ-AY50VGKP-E1	299/798/245	726,04	907,55
MSZ-EF22VG(K)B/W	299 / 885 / 195	548,58	685,73
MSZ-EF22VG(K)S	299 / 885 / 195	602,63	753,29
MSZ-EF25VG(K)B/W	299 / 885 / 195	554,7	693,38
MSZ-EF25VG(K)S	299 / 885 / 195	604,27	755,34
MSZ-EF35VG(K)B/W	299 / 885 / 195	633,53	791,91
MSZ-EF35VG(K)S	299 / 885 / 195	684,53	855,66
MSZ-EF42VG(K)B/W	299 / 885 / 195	723,07	903,84
MSZ-EF42VG(K)S	299 / 885 / 195	775,59	969,49
MSZ-EF50VG(K)B/W	299 / 885 / 195	801,91	1.002,39
MSZ-EF50VG(K)S	299 / 885 / 195	848,32	1.060,40
MSZ-LN25VGW*	307 / 890 / 233	676,91	846,14
MSZ-LN25VGB/R/V*	307 / 890 / 233	793,31	991,64
MSZ-LN35VGW*	307 / 890 / 233	787,06	983,83
MSZ-LN35VGB/R/V*	307 / 890 / 233	939,23	1.174,04
MSZ-LN50VGW*	307 / 890 / 233	826,01	1.032,51
MSZ-LN50VGB/R/V*	307 / 890 / 233	1.001,32	1.251,65
MSZ-LN60VGW*	307 / 890 / 233	951,62	1.189,53
MSZ-LN60VGB/R/V*	307 / 890 / 233	1.147,24	1.434,05
MSZ-RW25VG	305 / 998 / 247	635,00	793,75
MSZ-RW35VG	305 / 998 / 247	752,94	941,18
MSZ-RW50VG	305 / 998 / 247	779,27	974,09

*B - CRNA, R - CRVENA
V - BISERNO BIJELA
W - BIJELA

PODNA IZVEDBA



KANALSKA IZVEDBA

MODEL	DIMENZIJE V/S/D (mm)	CIJENA (€)	
		VPC	MPC
Uz uređaj je potrebno kupiti i PAR-40MAA ili PAC-YT52CRA-J.			
SEZ-M25DA	200 / 790 / 700	568,12	710,15
SEZ-M35DA	200 / 990 / 700	620,96	776,20
SEZ-M50DA	200 / 990 / 700	679,54	849,43
SEZ-M60DA	200 / 1190 / 700	802,53	1.003,16
SEZ-M71DA	200 / 1190 / 700	1.088,98	1.361,23

MODEL	DIMENZIJE V/S/D (mm)	CIJENA (€)	
		VPC	MPC
MFZ-KT25VG	600 / 750 / 215	924,68	1.155,85
MFZ-KT35VG	600 / 750 / 215	983,81	1.229,76
MFZ-KT50VG	600 / 750 / 215	1567,31	1.959,14
MFZ-KT60VG	600 / 750 / 215	1802,34	2.252,93
MFZ-KT25VGK	600 / 750 / 215	970,92	1.213,65
MFZ-KT35VGK	600 / 750 / 215	1.033,00	1.291,25
MFZ-KT50VGK	600 / 750 / 215	1.635,67	2.044,59
MFZ-KT60VGK	600 / 750 / 215	1.856,41	2.320,51
SFZ-M25VA.TH	615 (690) / 797 (700) / 200	654,31	817,89
SFZ-M35VA.TH	615 (690) / 997 (900) / 200	718,71	898,39
SFZ-M50VA.TH	615 (690) / 997 (900) / 200	827,21	1.034,01
SFZ-M60VA.TH	615 (690) / 1197 (1100) / 200	950,42	1.188,03
SFZ-M71VA.TH	615 (690) / 1197 (1100) / 200	1093,92	1.367,40

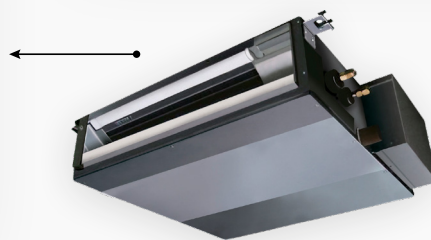

KAZETNA IZVEDBA

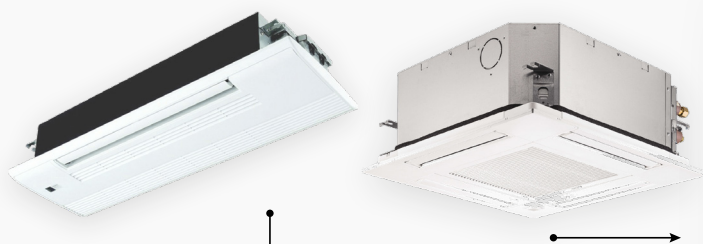

1-SMJERNA

MODEL	DIMENZIJE V/S/D (mm)	CIJENA (€)	
		VPC	MPC
MLZ-KP25VG-E1	185 / 1102 / 360	812,72	1.070,74 1.338,43
MLP-444W	24 / 1200 / 424	258,02	
MLZ-KP35VG-E1	185 / 1102 / 360	967,23	1.225,25 1.531,56
MLP-444W	24 / 1200 / 424	258,02	
MLZ-KP50VG-E1	185 / 1102 / 360	1285,41	1.543,43 1.929,29
MLP-444W	24 / 1200 / 424	258,02	

4-SMJERNA

MODEL	DIMENZIJE V/S/D (mm)	CIJENA (€)	
		VPC	MPC
SLZ-M15FA	245 / 570 / 570	506,97	
PAR-41MAA	120 / 120 / 14,5	211,47	915,15 1.143,94
SLP-2FAL	10 / 625 / 625	196,71	
SLZ-M25FA2.TH	245 / 570 / 570	531	
PAR-41MAA	120 / 120 / 14,5	211,47	939,18 1.173,98
SLP-2FAL	10 / 625 / 625	196,71	
SLZ-M35FA2.TH	245 / 570 / 570	603,08	
PAR-41MAA	120 / 120 / 14,5	211,47	1.011,26 1.264,08
SLP-2FAL	10 / 625 / 625	196,71	
SLZ-M50FA2.TH	245 / 570 / 570	762,05	
PAR-41MAA	120 / 120 / 14,5	211,47	1.170,23 1.462,79
SLP-2FAL	10 / 625 / 625	196,71	
SLZ-M60FA2.TH	245 / 570 / 570	808,45	
PAR-41MAA	120 / 120 / 14,5	211,47	1.216,63 1.520,79
SLP-2FAL	10 / 625 / 625	196,71	
SLZ-M15FA	245 / 570 / 570	506,97	
SLP-2FALM	10 / 625 / 625	255,08	762,05 952,56
SLZ-M25FA2.TH	245 / 570 / 570	531,00	
SLP-2FALM	10 / 625 / 625	255,08	786,08 982,60
SLZ-M35FA2.TH	245 / 570 / 570	603,08	
SLP-2FALM	10 / 625 / 625	255,08	858,16 1.072,70
SLZ-M50FA2.TH	245 / 570 / 570	762,05	
SLP-2FALM	10 / 625 / 625	255,08	1.017,13 1.271,41
SLZ-M60FA2.TH	245 / 570 / 570	808,45	
SLP-2FALM	10 / 625 / 625	255,08	1.063,53 1.329,41

UPUTE I NAPOMENE

MSZ-BT 20/25/35 moguće spojiti samo na R32 multi sustave.
 MSZ/SEZ/MLZ/SLZ-35FA = nije moguće spojiti s MXZ-2F33VF
 MSZ/SEZ/MLZ/SLZ-50FA = nije moguće spojiti s MXZ-2F42VF
 SEZ-60DA = nije moguće spojiti s MXZ-2F42/53VF, MXZ-3F54VF
 MFZ-KT podne jedinice moguće je spojiti s MXZ R32
 SEZ-71DA moguće spojiti samo na MXZ-4E83VA i veće modele
 MXZ-HA = moguće je spojiti samo na MSZ-HR modele unutarnjih jedinica
 MELCloud Wi-Fi sučelje nije moguće spojiti na MSZ-HJ, PCA-RP71/125HA, PEA-RP400/500GAQ



Osim navedenih modela unutarnjih jedinica, na multi DC inverter vanjske jedinice moguće je spojiti i slijedeće modele unutarnjih jedinica komercijalne serije:

KAZETNA: PLA-RP 50/60/71 EA, PODSTROPNA: PCA-M 50/60/71 KA,

KANALNA: PEAD-M 50/60/71 JA(L)

Za detalje pogledati komercijalni katalog ili tehničke upute.

UPRAVLJANJE ZA "RAC" I "S" SERIJU DODATNA OPREMA

MODEL	OBJAŠNENJE	CIJENA (€)	
		VPC	MPC
MAC-587IF-E  	Wi-Fi CONTROL INTERFACE: Kontrola unutarnjih jedinica preko aplikacije na smartphoneu, tabletu ili računalu.	80,57	100,71

Napomena: Potreban je po jedan interface na svaku unutarnju jedinicu.

MODEL	OBJAŠNENJE	CIJENA (€)	
		VPC	MPC
"A" KONTROLA			
MAC-497IF-E	"A" CONTROL TERMINAL INTERFACE (Potreban je po jedan interface na svaku unutarnju jedinicu)	163,5	204,38
PAC-YT52CRA-K	Žičani daljinski upravljač	149,59	186,99
PAR-41MAAB	Luksuzni žičani daljinski upravljač s Weekly Timer funkcijom	211,47	264,34
PAR-CT01MAA-SB	Multifunkcionalni deluxe daljinski žičani upravljač s LCD zaslonom u bijeloj boji	312,44	390,55
PAR-CT01MAA-PB	Multifunkcionalni deluxe daljinski žičani upravljač s LCD zaslonom u crnoj boji	373,43	466,79
"M-NET" KONTROLA			
MAC-334IF-E	"M-NET" INTERFACE (Potreban je po jedan interface na svaku unutarnju jedinicu)	232,3	290,38
PAR-U02MEDA-J	Luskuzni žičani daljinski upravljač sa senzorom prisutnosti	355,24	444,05

Napomena: za svaki navedeni daljinski upravljač iz "A" kontrole potrebno je spojiti jedan interface MAC-334IF-E ili MAC-497IF-E. Osim navedenog, moguće je spojiti bilo koji upravljač, kontrolu ili nadzor iz VRF serije, a koji pripadaju "A" kontroli te se sustavno povezati s PAC ili VRF serijom.

Napomena: za navedeni daljinski upravljač iz "M-NET" kontrole potrebno je spojiti jedan interface MAC-334IF-E. Osim navedenog, moguće je spojiti bilo koji upravljač, kontrolu ili nadzor iz VRF serije, a koji pripadaju "M-NET" kontroli te se sustavno povezati s PAC ili VRF serijom.

MODEL	MXZ-2F33VF3 *3	MXZ-2F42VF3 *3	MXZ-2F53VF(H) *3	MXZ-2DM40VA *3	MXZ-2F53VFHZ *3	MXZ-3F54VF3 *3	MXZ-3F68VF3 *3	MXZ-3DM50VA *3	MXZ-3HA50VF *3	MXZ-4F72VF3 *3	MXZ-4E83VA *3	MXZ-4F80VF3 *3	MXZ-4F83VF *3	MXZ-5E102VA *3	MXZ-5F102VF *3	MXZ-6D122VA *3	MXZ-6F122VF *3	MXZ-2HA40VF *3	MXZ-2HA50VF *3	MXZ-3HA50VF *3
	A	2			3			4			5		6		2		3			
B	50	60	70	60	75	100	120	85	85	125	145	125	145	172	172	180	180	60	67	85
MSZ-LN18	•	•	•		•	•	•			•		•	•		•		•			
MSZ-LN25	•	•	•		•	•	•			•		•	•	•	•	•	•			
MSZ-LN35		•	•		•	•	•			•		•	•	•	•	•	•			
MSZ-LN50						•	•			•		•	•	•	•	•	•			
MSZ-FT25VG														•		•				
MSZ-FT35VG														•		•				
MSZ-FT50VG														•		•				
MSZ-AP15VG(K)	•	•	•		•	•	•			•		•	•	•	•	•	•			
MSZ-AP20VG(K)	•	•	•		•	•	•			•		•	•	•	•	•	•			
MSZ-AP25VG(K)	•	•	•		•	•	•			•		•	•	•	•	•	•			
MSZ-AP35VG(K)		•	•		•	•	•			•		•	•	•	•	•	•			
MSZ-AP42VG(K)			•		•	•	•			•		•	•	•	•	•	•			
MSZ-AP50VG(K)			•		•	•	•			•		•	•	•	•	•	•			
MSZ-AP60VG(K)							•			•		•	•	•	•	•	•			
MSZ-AP71VG(K)													•	•	•	•	•			
MSZ-EF18VG	•	•	•		•	•	•			•		•	•	•	•	•	•			
MSZ-EF22VG	•	•	•		•	•	•			•		•	•	•	•	•	•			
MSZ-EF25VG	•	•	•		•	•	•			•		•	•	•	•	•	•			
MSZ-EF35VG		•	•		•	•	•			•		•	•	•	•	•	•			
MSZ-EF42VG			•		•	•	•			•		•	•	•	•	•	•			
MSZ-EF50VG			•		•	•	•			•		•	•	•	•	•	•			
MSZ-BT20VG(K)	•	•	•		•	•	•			•		•	•		•		•			
MSZ-BT25VG(K)	•	•	•		•	•	•			•		•	•		•		•			
MSZ-BT35VG(K)		•	•		•	•	•			•		•	•		•		•			
MSZ-BT50VG(K)																				
MSZ-HR25VF									•									•	•	•
MSZ-HR35VF									•										•	•
MSZ-HR42VF									•											•
MSZ-HR50VF									•											
MSZ-HR60VF									•											
MSZ-HR71VF																				

*1 Maksimalan broj unutarnjih jedinica: 3A ili manje

*2 SEZ-M25 ne može biti povezan s MXZ-2F/3F/4F kada je ukupan kapacitet unutarnjih jedinica jednak kapacitetu vanjske jedinice (omjer kapaciteta jednak 1)

*3 MXZ vanjske jedinice nisu dizajnirane za rad s jednom unutarnjom jedinicom.

Potrebna instalacija minimalno dvije unutarnje jedinice

MODEL	MXZ-2F33VF3 *3	MXZ-2F42VF3 *3	MXZ-2F53VF(H) *3	MXZ-2DM40VA *3	MXZ-2F53VFHZ *3	MXZ-3F54VF3 *3	MXZ-3F68VF3 *3	MXZ-3DM50VA *3	MXZ-3HA50VF *3	MXZ-4F72VF3 *3	MXZ-4E83VA *3	MXZ-4F80VF3 *3	MXZ-4F83VF *3	MXZ-5E102VA *3	MXZ-5F102VF *3	MXZ-6D122VA *3	MXZ-6F122VF *3	MXZ-2HA40VF *3	MXZ-2HA50VF *3	MXZ-3HA50VF *3
A	2				3				4				5		6		2		3	
B	50	60	70	60	75	100	120	85	85	125	145	125	145	172	172	180	180	60	67	85
MFZ-KT25VG	•	•	•		•	•	•			•		•	•	•	•	•	•			
MFZ-KT35VG		•	•		•	•	•			•		•	•	•	•	•	•			
MFZ-KT50VG						•	•			•		•	•	•	•	•	•			
MLZ-KP25VF	•	•	•		•	•	•		•	•		•	•	•	•	•	•			
MLZ-KP35VF		•	•		•	•	•		•	•		•	•	•	•	•	•			
MLZ-KP50VF						•	•		•	•		•	•	•	•	•	•			
SLZ-M15FA	•	•	•		•	•	•			•		•	•		•		•			
SLZ-M25FA	•	•	•		•	•	•			•		•	•	•	•	•	•			
SLZ-M35FA		•	•		•	•	•			•		•	•	•	•	•	•			
SLZ-M50FA						•	•			•		•	•	•	•	•	•			
SEZ-M25DA *2	•	•	•		•	•	•			•		•	•	•	•	•	•			
SEZ-M25DAL *2	•	•	•		•	•	•			•		•	•	•	•	•	•			
SEZ-M35DA		•	•		•	•	•			•		•	•	•	•	•	•			
SEZ-M35DAL		•	•		•	•	•			•		•	•	•	•	•	•			
SEZ-M50DA						•	•			•		•	•	•	•	•	•			
SEZ-M50DAL						•	•			•		•	•	•	•	•	•			
SEZ-M60DA							•			•		•	•	•	•	•	•			
SEZ-M60DAL							•			•		•	•	•	•	•	•			
SEZ-M71DA													•	•	•	•	•			
SEZ-M71DAL													•	•	•	•	•			
PCA-M50KA						•	•			•		•								
PCA-M60KA							•			•		•								
PCA-M71KA																				
PEAD-M50JA						•*1	•*1			•*1		•								
PEAD-M50JAL						•*1	•*1			•*1		•								
PEAD-M60JA																				
PEAD-M60JAL																				
PEAD-M71JA																				
PEAD-M71JAL																				

*1 Maksimalan broj unutarnjih jedinica: 3A ili manje

*2 SEZ-M25 ne može biti povezan s MXZ-2F/3F/4F kada je ukupan kapacitet unutarnjih jedinica jednak kapacitetu vanjske jedinice (omjer kapaciteta jednak 1)

*3 MXZ vanjske jedinice nisu dizajnirane za rad s jednom unutarnjom jedinicom. Potrebna instalacija minimalno dvije unutarnje jedinice

MODEL	UČINAK hlađenje / grijanje (kW)	Promjer cijevi [tekućina/plin] (mm)	Razmak između nosača	Napajanje na jedinicu	Međuveza vanjske i unutarnje jedinice	Max. duljina / visinska razlika cijevi (m)	Prednapunjena duljina cijevi do	Nadopuna plina nakon udaljenosti prednadopune
MONO SPLIT (INVERTER) - R410A / *R32								
ZIDNA IZVEDBA								
MSZ-DW25VF*	2,5 / 3,15	6,35 / 9,52	500 mm	vanjsku 3 x 1,0 mm ²	4 x 1,0 mm ²	20 / 12	7,5 m	20 g/m
MSZ-DW35VF*	3,4 / 3,6	6,35 / 9,52	500 mm	vanjsku 3 x 1,0 mm ²	4 x 1,0 mm ²	20 / 12	7,5 m	20 g/m
MSZ-DW50VF*	5,0 / 5,4	6,35 / 9,52	500 mm	vanjsku 3 x 1,5 mm ²	4 x 1,0 mm ²	20 / 12	7,5 m	20 g/m
MSZ-RW25VG	2,5 / 3,2	6,35 / 9,52	500 mm	vanjsku 3 x 1,0 mm ²	4 x 1,0 mm ²	20 / 12	10 m	20 g/m
MSZ-RW35VG	3,5 / 4,0	6,35 / 9,52	500 mm	vanjsku 3 x 1,5 mm ²	4 x 1,0 mm ²	20 / 12	10 m	20 g/m
MSZ-RW50VG	5,0 / 6,0	6,35 / 9,52	500 mm	vanjsku 3 x 2,0 mm ²	4 x 1,0 mm ²	30 / 15	15 m	20 g/m
MSZ-FT25VGK-E2	2,5 / 3,2	6,35 / 9,52	500 mm	vanjsku 3 x 1,0 mm ²	4 x 1,0 mm ²	20 / 12	7 m	20 g/m
MSZ-FT35VGK-E2	3,5 / 4,0	6,35 / 9,52	500 mm	vanjsku 3 x 1,0 mm ²	4 x 1,0 mm ²	30 / 15	7 m	20 g/m
MSZ-FT50VGK-E2	5,0 / 5,0	6,35 / 9,52	500 mm	vanjsku 3 x 2,0 mm ²	4 x 1,0 mm ²	30 / 15	7 m	20 g/m
MSY-TP35VF-E2	3,5 / -	6,35 / 9,52	500 mm	vanjsku 3 x 1,0 mm ²	4 x 1,0 mm ²	20 / 12	7 m	10 g/m
MSY-TP50VF-E2	5,0 / -	6,35 / 9,52	500 mm	vanjsku 3 x 2,0 mm ²	4 x 1,0 mm ²	20 / 12	7 m	10 g/m
MSZ-LN25VG*	2,50 / 3,20	6,35 / 9,52	500 mm	vanjsku 3 x 1,0 mm ²	4 x 1,0 mm ²	20 / 12	10 m	20 g/m
MSZ-LN35VG*	3,50 / 4,00	6,35 / 9,52	500 mm	vanjsku 3 x 1,0 mm ²	4 x 1,0 mm ²	20 / 12	15 m	20 g/m
MSZ-LN50VG*	5,00 / 6,00	6,35 / 9,52	500 mm	vanjsku 3 x 2,0 mm ²	4 x 1,0 mm ²	20 / 12	15 m	20 g/m
MSZ-LN60VG*	6,10 / 6,80	6,35 / 12,7	500 mm	vanjsku 3 x 2,0 mm ²	4 x 1,0 mm ²	30 / 15	7 m	20 g/m
MSZ-FH25VE	2,50 / 3,20	6,35 / 9,52	500 mm	vanjsku 3 x 1,00 mm ²	4 x 1,0 mm ²	20 / 12	7 m	30 g/m
MSZ-FH35VE	3,50 / 4,00	6,35 / 9,52	500 mm	vanjsku 3 x 1,0 mm ²	4 x 1,0 mm ²	20 / 12	7 m	30 g/m
MSZ-FH50VE	5,00 / 6,00	6,35 / 12,7	500 mm	vanjsku 3 x 2,0 mm ²	4 x 1,0 mm ²	30 / 15	7 m	20 g/m
MSZ-EF25VE	2,50 / 3,20	6,35 / 9,52	500 mm	vanjsku 3 x 1,0 mm ²	4 x 1,0 mm ²	20 / 12	7 m	30 g/m
MSZ-EF35VE	3,50 / 4,00	6,35 / 9,52	500 mm	vanjsku 3 x 1,0 mm ²	4 x 1,0 mm ²	20 / 12	7 m	30 g/m
MSZ-EF42VE	4,20 / 5,40	6,35 / 9,52	500 mm	vanjsku 3 x 1,5 mm ²	4 x 1,0 mm ²	20 / 12	7 m	30 g/m
MSZ-EF50VE	5,00 / 5,80	6,35 / 9,52	500 mm	vanjsku 3 x 2,0 mm ²	4 x 1,0 mm ²	30 / 15	7 m	20 g/m
MSZ-BT20VG	2,0 / 2,5	6,35 / 9,52	500 mm	vanjsku 3 x 1,0 mm ²	4 x 1,0 mm ²	20 / 12	7 m	20 g/m
MSZ-BT25VG	2,5 / 3,15	6,35 / 9,52	500 mm	vanjsku 3 x 1,0 mm ²	4 x 1,0 mm ²	20 / 12	7 m	20 g/m
MSZ-BT35VG	3,5 / 3,6	6,35 / 9,52	500 mm	vanjsku 3 x 1,0 mm ²	4 x 1,0 mm ²	20 / 12	7 m	20 g/m
MSZ-BT50VG	5,0 / 5,4	6,35 / 12,7	500 mm	vanjsku 3 x 1,5 mm ²	4 x 1,0 mm ²	20 / 12	7 m	20 g/m
MSZ-GF60VE	6,10 / 6,80	6,35 / 15,88	500 mm	vanjsku 3 x 2,5 mm ²	4 x 1,0 mm ²	30 / 15	10 m	20 g/m
MSZ-GF71VE	7,10 / 8,10	9,52 / 15,88	500 mm	vanjsku 3 x 2,5 mm ²	4 x 1,0 mm ²	30 / 15	10 m	55 g/m

MODEL	UČINAK hlađenje / grijanje (kW)	Promjer cijevi [tekućina/plin] (mm)	Razmak između nosača	Napajanje na jedinicu	Međuveza vanjske i unutarnje jedinice	Max. duljina / visinska razlika cijevi (m)	Prednapunjena duljina cijevi do	Nadopuna plina nakon udaljenosti prednadopune
MSZ-A15VKGK-E1	1,5 / 2,0	6,35 / 9,52	500 mm	vanjsku 3 x 1,0 mm ²	4 x 1,0 mm ²	20 / 12	7 m	20 g/m
MSZ-A20VKGK-E1	2,0 / 2,5	6,35 / 9,52	500 mm	vanjsku 3 x 1,0 mm ²	4 x 1,0 mm ²	20 / 12	7 m	20 g/m
MSZ- A15VKGK(P)	2,5 / 3,2	6,35 / 9,52	500 mm	vanjsku 3 x 1,0 mm ²	4 x 1,0 mm ²	20 / 12	7 m	20 g/m
MSZ- A15VKGK(P)	3,5 / 4,0	6,35 / 9,52	500 mm	vanjsku 3 x 1,0 mm ²	4 x 1,0 mm ²	20 / 12	7 m	20 g/m
MSZ- A15VKGK(P)	4,2 / 5,2	6,35 / 9,52	500 mm	vanjsku 3 x 1,0 mm ²	4 x 1,0 mm ²	20 / 12	7 m	20 g/m
MSZ- A15VKGK(P)	5,0 / 5,5	6,35 / 9,52	500 mm	vanjsku 3 x 2,0 mm ²	4 x 1,0 mm ²	20 / 12	7 m	20 g/m
MSZ-HR25VA*	2,50 / 3,10	6,35 / 9,52	500 mm	vanjsku 3 x 1,0 mm ²	4 x 1,0 mm ²	20 / 12	7 m	20 g/m
MSZ-HR35VA*	3,40 / 3,60	6,35 / 9,52	500 mm	vanjsku 3 x 1,0 mm ²	4 x 1,0 mm ²	20 / 12	7 m	20 g/m
MSZ-HR42VA*	4,20 / 4,70	6,35 / 9,52	500 mm	vanjsku 3 x 1,0 mm ²	4 x 1,0 mm ²	20 / 12	7 m	20 g/m
MSZ-HR50VA*	5,00 / 5,40	6,35 / 9,52	500 mm	vanjsku 3 x 1,5 mm ²	4 x 1,0 mm ²	20 / 12	7 m	20 g/m
MSZ-HR60VA*	6,10 / 6,80	6,35 / 12,7	500 mm	vanjsku 3 x 2,0 mm ²	4 x 1,0 mm ²	30 / 15	7 m	20 g/m
MSZ-HR71VA*	7,10 / 8,10	6,35 / 12,7	500 mm	vanjsku 3 x 2,0 mm ²	4 x 1,0 mm ²	30 / 15	7 m	20 g/m

MODEL	UČINAK hlađenje / grijanje (kW)	Promjer cijevi [tekućina/plin] (mm)	Razmak između nosača	Napajanje na jedinicu	Međuveza vanjske i unutarnje jedinice	Max. duljina / visinska razlika cijevi (m)	Pred- napunjena duljina cijevi do	Nadopuna plina nakon udaljenosti prednadopune
PODNA IZVEDBA								
MFZ-KT25VG*	2,50 / 3,40	6,35 / 9,52	500 mm	vanjsku 3 x 1,5 mm ²	4 x 1,5 mm ²	20 / 12	7 m	20 g/m
MFZ-KT35VG*	3,50 / 4,30	6,35 / 9,52	500 mm	vanjsku 3 x 1,5 mm ²	4 x 1,5 mm ²	20 / 12	7 m	20 g/m
MFZ-KT50VG*	5,00 / 6,00	6,35 / 12,7	500 mm	vanjsku 3 x 1,5 mm ²	4 x 1,5 mm ²	30 / 30	7 m	20 g/m
MFZ-KT60VG*	6,00 / 7,00	6,35 / 15,88	500 mm	vanjsku 3 x 1,5 mm ²	4 x 1,5 mm ²	30 / 30	7 m	20 g/m
SFZ-M25VA.TH	2,5 / 3,2	6,35 / 9,52	500 mm	vanjsku 3 x 1,5 mm ²	4 x 1,5 mm ²	20 / 12	7 m	30 g/m
SFZ-M35VA.TH	3,5 / 4,1	6,35 / 9,52	500 mm	vanjsku 3 x 2,0 mm ²	4 x 1,5 mm ²	20 / 12	7 m	30 g/m
SFZ-M50VA.TH	5,0 / 6,0	6,35 / 12,7	500 mm	vanjsku 3 x 2,5 mm ²	4 x 1,5 mm ²	30 / 30	7 m	20 g/m
SFZ-M60VA.TH	6,1 / 7,0	6,35 / 15,88	500 mm	vanjsku 3 x 2,5 mm ²	4 x 1,5 mm ²	30 / 30	7 m	20 g/m
SFZ-M71VA.TH	7,1 / 8,0	9,52 / 15,88	500 mm	vanjsku 3 x 2,5 mm ²	4 x 1,5 mm ²	30 / 30	7 m	55 g/m
KAZETNA IZVEDBA - 4-smjerna								
SLZ-M25FA	2,60 / 3,20	6,35 / 9,52	500 mm	vanjsku 3 x 1,5 mm ²	4 x 1,5 mm ²	20 / 12	7 m	30 g/m
SLZ-M35FA	3,50 / 4,00	6,35 / 9,52	500 mm	vanjsku 3 x 1,5 mm ²	4 x 1,5 mm ²	20 / 12	7 m	30 g/m
SLZ-M50FA	4,60 / 5,00	6,35 / 12,7	500 mm	vanjsku 3 x 2,5 mm ²	4 x 1,5 mm ²	30 / 30	7 m	20 g/m
SLZ-M60FA	5,60 / 6,40	6,35 / 15,88	500 mm	vanjsku 3 x 2,5 mm ²	4 x 1,5 mm ²	30 / 30	7 m	20 g/m
KAZETNA IZVEDBA - 1-smjerna								
MLZ-KP25VF	2,50 / 3,20	6,35 / 9,52	500 mm	vanjsku 3 x 1,5 mm ²	4 x 1,5 mm ²	20 / 12	7 m	30 g/m
MLZ-KP35VF	3,50 / 4,10	6,35 / 9,52	500 mm	vanjsku 3 x 1,5 mm ²	4 x 1,5 mm ²	20 / 12	7 m	30 g/m
MLZ-KP50VF	5,00 / 6,00	6,35 / 12,7	500 mm	vanjsku 3 x 2,5 mm ²	4 x 1,5 mm ²	30 / 30	7 m	20 g/m

MODEL	UČINAK hlađenje / grijanje (kW)	Promjer cijevi [tekućina/plin] (mm)	Razmak između nosača	Napajanje na jedinicu	Međuveza vanjske i unutarnje jedinice	Max. duljina / visinska razlika cijevi (m)	Pred- napunjena duljina cijevi do	Nadopuna plina nakon udaljenosti prednadopune
KANALSKA IZVEDBA								
SEZ-M25DA	2,50 / 2,90	6,35 / 9,52	500 mm	vanjsku 3 x 1,5 mm ²	4 x 1,5 mm ²	20 / 12	7 m	30 g/m
SEZ-M35DA	3,50 / 4,20	6,35 / 9,52	500 mm	vanjsku 3 x 1,5 mm ²	4 x 1,5 mm ²	20 / 12	7 m	30 g/m
SEZ-M50DA	5,00 / 6,00	6,35 / 12,7	500 mm	vanjsku 3 x 2,5 mm ²	4 x 1,5 mm ²	30 / 30	7 m	20 g/m
SEZ-M60DA	6,10 / 7,40	6,35 / 15,88	500 mm	vanjsku 3 x 2,5 mm ²	4 x 1,5 mm ²	30 / 30	7 m	20 g/m
SEZ-M71DA	7,10 / 8,00	9,52 / 15,88	500 mm	vanjsku 3 x 2,5 mm ²	4 x 1,5 mm ²	30 / 30	7 m	55 g/m
MULTI SPLIT VANJSKE JEDINICE - *Napomena: Maksimalna visinska razlika ukoliko je vanjska jedinica montirana iznad unutarnje								
MXZ-2F33VF	3,30 / 4,00	2x (6,35 / 9,52)	500 mm	vanjsku 3 x 2,5 mm ²	2x (4 x 1,5 mm ²)	20 / 10 (pojedinačno unutarnja max. 15m)	20 m	0
MXZ-2F42VF	4,20 / 4,50	2x (6,35 / 9,52)	500 mm	vanjsku 3 x 2,5 mm ²	2x (4 x 1,5 mm ²)	30 / 15 (10*) (pojedinačno unutarnja max. 20m)	30 m	0
MXZ-2F53VF	5,30 / 6,40	2x (6,35 / 9,52)	500 mm	vanjsku 3 x 2,5 mm ²	2x (4 x 1,5 mm ²)	30 / 15 (10*) (pojedinačno unutarnja max. 20m)	30 m	0
MXZ-3F54VF	5,40 / 7,00	3x (6,35 / 9,52)	500 mm	vanjsku 3 x 2,5 mm ²	3x (4 x 1,5 mm ²)	50 / 15 (10*) (pojedinačno unutarnja max. 25m)	50 m	0
MXZ-3F68VF	6,80 / 8,60	3x (6,35 / 9,52)	500 mm	vanjsku 3 x 2,5 mm ²	3x (4 x 1,5 mm ²)	60 / 15 (10*) (pojedinačno unutarnja max. 25m)	60 m	0
MXZ-4F72VF	7,20 / 8,60	4x 6,35 / 3x 9,52 + 1x 12,7	500 mm	vanjsku 3 x 2,5 mm ²	4x (4 x 1,5 mm ²)	60 / 15 (10*) (pojedinačno unutarnja max. 25m)	60 m	0
MXZ-4F83VF	8,30 / 9,00	4x 6,35 / 3x 9,52 + 1x 12,7	600 mm	vanjsku 3 x 2,5 mm ²	4x (4 x 1,5 mm ²)	70 / 15 (pojedinačno unutarnja max. 25m)	70 m	0
MXZ-5F102VF	10,20 / 10,50	5x 6,35 / 4x 9,52 + 1x 12,7	600 mm	vanjsku 3 x 2,5 mm ²	5x (4 x 1,5 mm ²)	80 / 15 (pojedinačno unutarnja max. 25m)	80 m	0
MXZ-6F120VF	12,20 / 14,00	6x 6,35 / 5x 9,52 + 1x 12,7	600 mm	vanjsku 3 x 4,0 mm ²	6x (4 x 1,5 mm ²)	80 / 15 (pojedinačno unutarnja max. 25m)	80 m	0
MXZ-2HA40VF	4,00 / 4,30	2x (6,35 / 9,52)	500 mm	vanjsku 3 x 2,0 mm ²	2x (4 x 1,5 mm ²)	30 / 15 (pojedinačno unutarnja max. 20m)	30 m	0
MXZ-2HA50VF	5,00 / 6,00	2x (6,35 / 9,52)	500 mm	vanjsku 3 x 2,0 mm ²	2x (4 x 1,5 mm ²)	30 / 15 (10) (pojedinačno unutarnja max. 20m)	30 m	0
MXZ-3HA50VF	5,00 / 6,00	3x (6,35 / 9,52)	500 mm	vanjsku 3 x 2,5 mm ²	3x (4 x 1,5 mm ²)	50 / 15 (10) (pojedinačno unutarnja max. 25m)	40 m	20 g/m

* Za VF2/VF3 ne treba nadopuna plina.

MODEL	UČINAK hlađenje / grijanje (kW)	Promjer cijevi [tekućina/plin] (mm)	Razmak između nosača	Napajanje na jedinicu	Međuveza vanjske i unutarnje jedinice	Max. duljina / visinska razlika cijevi (m)	Prednapunjena duljina cijevi do	Nadopuna plina nakon udaljenosti prednadopune
PUMY-SP112VK	12,50 / 14,00	9,52 / 15,88	600 mm	vanjsku 3 x 6,0 mm ²	Navedeni podaci za slučaj spajanja Branch Box i RAC/ PAC unutarnjih jedinica: vanjska → B.Box 1-2 x (3 x 1,5 mm ² + oklopljeni Liycy 2 x 1,25 mm ²) B.Box → unutarnje 2-8 x (4 x 1,5 mm ²)	Navedeni podaci za slučaj spajanja Branch Box(ova) i RAC/PAC unutarnjih jedinica:	0 m	Kontaktirati Deltron
PUMY-SP125VK	14,00 / 16,00	9,52 / 15,88	600 mm	vanjsku 3 x 6,0 mm ²		120 / 30 (50*)m pojedinačno unutarnja max.: 80m	0 m	
PUMY-SP140VK	15,50 / 16,50	9,52 / 15,88	600 mm	vanjsku 3 x 6,0 mm ²		od vanjske do B.Box max. 55m	0 m	
PUMY-SP112YK	12,50 / 14,00	9,52 / 15,88	600 mm	vanjsku 5 x 2,5 mm ²		max. od B.Box do unutarnjih: 95m	0 m	
PUMY-SP125YK	14,00 / 16,00	9,52 / 15,88	600 mm	vanjsku 5 x 2,5 mm ²		pojedinačno od B.Box do unutarnje: 25m	0 m	
PUMY-SP140YK	15,50 / 16,50	9,52 / 15,88	600 mm	vanjsku 5 x 2,5 mm ²		max.visina između unutarnjih: 12m max.visinska razl. B.Box i unutarnje: 15m	0 m	

MODEL	UČINAK hlađenje / grijanje (kW)	Promjer cijevi [tekućina/plin] (mm)	Razmak između nosača	Napajanje na jedinicu	Međuveza vanjske i unutarnje jedinice	Max. duljina / visinska razlika cijevi (m)	Prednapunjena duljina cijevi do	Nadopuna plina nakon udaljenosti prednadopune
PUMY-P112VK	12,50 / 14,00	9,52 / 15,88	600 mm	vanjsku 3 x 6,0 mm ²	Navedeni podaci za slučaj spajanja Branch Box i RAC/ PAC unutarnjih jedinica: vanjska → B.Box 1-2 x (3 x 1,5 mm ² + oklopljeni Liycy 2 x 1,25 mm ²) B.Box → unutarnje 2-8 x (4 x 1,5 mm ²)	Navedeni podaci za slučaj spajanja Branch Box(ova) i RAC/PAC unutarnjih jedinica:	0 m	Kontaktirati Deltron
PUMY-P125VK	14,00 / 16,00	9,52 / 15,88	600 mm	vanjsku 3 x 6,0 mm ²		150 / 40 (50*)m pojedinačno unutarnja max.: 80m	0 m	
PUMY-P140VK	15,50 / 18,00	9,52 / 15,88	600 mm	vanjsku 3 x 6,0 mm ²		od vanjske do B.Box max. 55m	0 m	
PUMY-P112YK	12,50 / 14,00	9,52 / 15,88	600 mm	vanjsku 5 x 2,5 mm ²		max. od B.Box do unutarnjih: 95m	0 m	
PUMY-P125YK	14,00 / 16,00	9,52 / 15,88	600 mm	vanjsku 5 x 2,5 mm ²		pojedinačno od B.Box do unutarnje: 25m	0 m	
PUMY-P140YK	15,50 / 18,00	9,52 / 15,88	600 mm	vanjsku 5 x 2,5 mm ²		max.visina između unutarnjih: 12m max.visinska razl. B.Box i unutarnje: 15m	0 m	
PUMY-P200YKM1	22,40 / 25,00	9,52 / 19,1	600 mm	vanjsku 5 x 2,5 mm ²	Navedeni podaci za slučaj spajanja Branch Box(ova) i RAC/PAC unutarnjih jedinica: vanjska → B.Box 1-2 x (3x1,5mm ² + oklopljeni Liycy 2x1,25mm ²) B.Box → unutarnje 2-8 x (4x1,5mm ²)	Navedeni podaci za slučaj spajanja Branch Box(ova) i RAC/PAC unutarnjih jedinica:	0 m	Kontaktirati Deltron
						150 / 40 (50*)m pojedinačno unutarnja max.: 80m od vanjske do B.Box max. 55m max. od B.Box do unutarnjih: 95m pojedinačno od B.Box do unutarnje: 25m max.visina između unutarnjih: 12m max.visinska razl. B.Box i unutarnje: 15m		

(KÓD) UNUTARNJE JEDINICE

15	1,50 / 1,70	6,35 / 9,52
18	1,80 / 3,30	6,35 / 9,52
20	2,00 / 2,20	6,35 / 9,52
22	2,20 / 3,30	6,35 / 9,52
25	2,50 / 3,20	6,35 / 9,52

***R32 MODELI**

35	3,50 / 4,00	6,35 / 9,52
42	4,20 / 5,40	6,35 / 9,52
50	5,00 / 5,80	6,35 / 12,7 *6,35/9,52
60	6,10 / 6,80	6,35 / 15,88
71	7,10 / 8,10	9,52 / 15,88

TABLICA ZA NADOPUNU FREONA MULTI SPLIT R32 UREĐAJA
Način punjenja rashladnim sredstvom

Ukupna količina rashladnog sredstva *3	=	Pretpunjenje	+	Broj unutarnje jedinice *1	+	Priključak pojedine UJ *2	+	Dužina cijevi
_____ kg		1,4 kg		_____ kg		_____ kg		0,0 kg

*1 Ako priključite 3 ili 4 unutarnje jedinice, dodajte **0,5 kg** rashladnog sredstva.

*2 Ako priključite sljedeću/e jedinicu/e, dodajte **0,17 kg po jednoj jedinici**.

MSZ-LN18/25/35VG MLZ-KP25/35/50VF
SEZ-M50DA(L) PCA-M50/60KA
PEAD-M50JA(L)

*3 Ako ukupna količina rashladnog sredstva za sve uređaje bude veća od **2,4 kg**, dopunite samo **1,0 kg** kako se ne bi prekoračila ukupna maksimalna količina.



K L I M A U R E Đ A J I

NAPOMENE:

Molimo da prije narudžbe provjerite isporučivost pojedinog uređaja.

GARANCIJA NA UREĐAJE:

36 mjeseci, uz pridržavanje uputa za rukovanje.

VALJANOST CJENIKA OD:

4.5.2026.

Zadržavamo pravo izmjena cijena, bez prethodne najave.

DISTRIBUTER

Split, Vukovarska 148
Tel: +385 (0)21 453 400
Fax: +385 (0)21 473 943
deltron@deltron.hr

Zagreb, Zagrebačka avenija 104
Tel: +385 (0)1 60 64 777
Fax: +385 (0)1 60 64 778
deltron.zagreb@deltron.hr

Sarajevo, Pijačna 14K
Tel: +387 (0)33 840 200
Fax: +387 (0)33 840 203
deltron.sarajevo@deltron.ba

DELTRON.HR

DIGITALNA VERZIJA



GENERALNI ZASTUPNIK
MITSUBISHI ELECTRIC
KLIMA-UREĐAJA

